

 *texi*®

Culture of Sewing



CUTTING	6
INDUSTRIAL SEWING MACHINES	14
MACHINES FOR HEAVY MATERIALS	43
EMBROIDERY MACHINES	56
ACCESSORIES FOR INDUSTRIAL SEWING MACHINES	58
NEEDLES FOR INDUSTRIAL SEWING MACHINES	64
NEEDLES FOR HOUSEHOLD SEWING MACHINES	66
HOUSEHOLD SEWING MACHINES	72
HOUSEHOLD ACCESSORIES	98
PATCHWORK	114
IRONING	118
FASTENING	124

© Strima Sp. z o.o. All rights reserved.

We have done everything to ensure that the information contained in this brochure is as precise and up-to-date as possible. In accordance with our strategy of continuous product development, we reserve the right to modify their elements or change technical parameters without notice. No part of this publication may be reproduced in any form without the written consent of the publisher. The brochure is for information purposes only and does not constitute a commercial offer. March 2026.



Culture of Sewing



TEXI is a complete solution for fashion, upholstery or leather ateliers. For sewing enthusiasts we also offer our support and advice.

TEXI's product portfolio includes industrial sewing machines and home sewing machines, ironing devices, labeling and sewing accessories.

Founded in 2011 as an answer to customer demand for energy saving, silent and user-friendly machines. TEXI today is distributed in more than 100 countries all over the world. We are part of high-class fashion and promotional events such as Project Runway and Art and Fashion Forum for promising talents.



Cutting

texi Titanium Scissors

- ✓ Blades surface hardened with titanium
- ✓ Maximum resistance
- ✓ Lifetime guarantee
- ✓ Soft grip



TI500

Titanium coated thread clip
5" (12 cm)



TI700

7" (18 cm) Titanium coated,
professional dressmaker
shears



TI914

9 1/4" (23,5 cm) Titanium
coated, professional
dressmaker shears



TI613 CRAFT

6 1/3" (16 cm) Titanium
coated scissors for
upholstery



TI514

5 1/4" (13 cm) Titanium
coated hobby - craft scissors



TI814

8 1/4" (21 cm) Titanium
coated, professional
dressmaker scissors



TIDUO850

Ti 514 + Ti 814
Titanium coated dressmaker
shears 8 1/4" (21 cm) and
hobby - craft 5 1/4" (13 cm)



Soft grip

texi Titanium



PRICE & INFO



CUTTING

texi. Round knife cutters

TEXI ZORRO 100

Round knife with
AC Servo motor



- blade diameter 100 mm
- direct drive AC Servo motor
- 5-step speed regulation
- cutting height 27 mm
- LED lamp
- quiet operation
- lightweight 1,3 kg



TEXI PROTECTIVE GLOVE

Protective glove
universal 5-finger



TEXI ZORRO 110 FREE

Cordless round knife
with DC Servo motor



BATTERY

32 MM



PRICE & INFO

- blade diameter 110 mm
- direct drive DC Servo motor
- 5-step speed regulation
- cutting height 32 mm
- LED lamp
- quiet operation
- lightweight 1,5 kg



LED



CUTTING

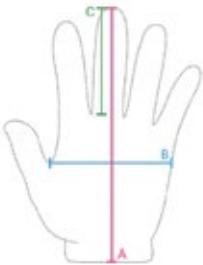

Size		Color	A	B	C
XXS	●	navy	200 mm	110 mm	80 mm
XS	●	green	220 mm	110 mm	85 mm
S	○	white	230 mm	120 mm	85 mm
M	●	red	240 mm	125 mm	90 mm
L	●	blue	250 mm	130 mm	90 mm
XL	●	orange	250 mm	130 mm	95 mm

texi Cutting machines

TEXI SIRIUS-P 1390

CO₂ plotter for cutting and engraving. A laser device for cutting and marking fabrics, wood, plastic, plexiglass, rubber, glass and ceramics.



PRICE & INFO



CO ₂ laser power	130 W
Working area	1300 x 900 mm
Standard lens	2"
Cutting speed	0 - 600 mm/sek
Engraving speed	0 - 1060 mm/sek
Positioning accuracy	+/- 0,05 mm
Cooling	Water
Smoke extraction system	Turbine
Table type	Honeycomb and ribbed
Table height adjustment	Electronic
Control panel	3" LCD panel Motors: AC SERVO
Supported image file formats	PLT, AI, DXF, DST, BMP, JPG, etc.
Additional options	Rotary attachment, 3" lens (for cutting thicker materials materials)

TEXI XYZ 2517

Modern single-layer cutter with conveyor system designed for automatic cutting of fabrics, synthetic materials, technical fabrics, leather and other materials.



PRICE & INFO



Working area	2 500 x 1 700 mm
Device dimensions	3 350 x 2 550 mm
The minimum width of the wall opening through which the device can be installed in the factory	2 600 mm with bridge / 2 150 mm without bridge
Width and length of the material feeder with motor	2 170 mm / 1 100 mm
Total length of the device with the installed feeder	5 520 mm + 600 mm computer / min. 6m
Maximum cutting speed	1500 mm/s
Cutting accuracy	to 0,1 mm
Maximum cutting thickness	to 50 mm
Engines	AC Servo
Turbine power	7,5 kW
Total device power	9 kW
Power supply	400 V, 3 phases
Software language	English
File handling	PLT/HPGL, DXF, PDF

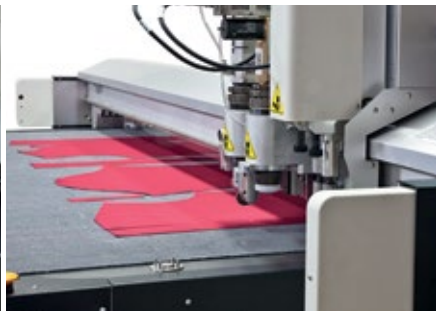

Accessories for a cutter

TEXI XYZ 2517 TABLE

The receiving table allows the cutter to operate continuously – without any downtime for removing cut pieces. The operator gains additional workspace, and the transfer and sorting of material proceeds smoothly without interrupting the cutter's operation.

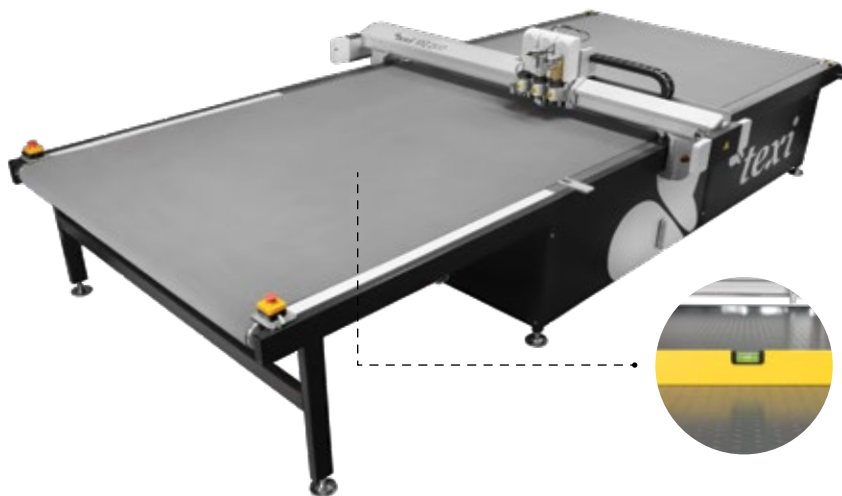

Receiving table:

TEXI XYZ 2517 TABLE 1500MM – increases efficiency by up to 20%

TEXI XYZ 2517 TABLE 2500MM – increases efficiency by up to 30%

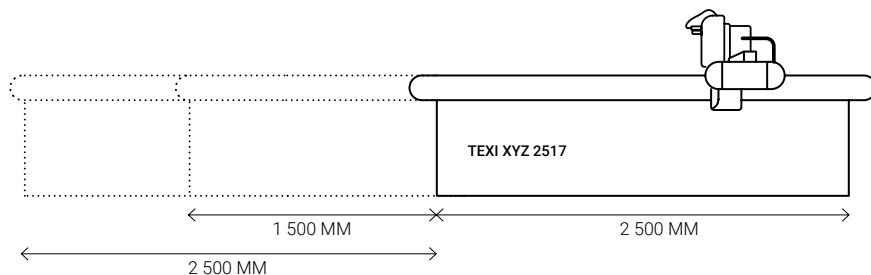

TEXI FLOW

Automatic feeder

- Max. material beam diameter: 400 mm
- Max. material beam width: 1800 mm
- Correction accuracy: 5 mm
- Maximum bearing load: 80 kg
- Max. feed speed: 350 mm/s

Edge detection sensor – thanks to automatic path correction, you don't need to worry about keeping the cutting edge

Quick roll change – the first machine with such a fast and intuitive roll change system for the material



PRICE & INFO



TEXI XYZ 2517 CBC























Conveyor belt cleaning device. Keeps the conveyor belt clean, thereby reducing maintenance time to a minimum. Less work for staff and greater productivity. Even when working with difficult materials, fibre residue and debris from cutting are minimal, which is particularly important when changing material colours.















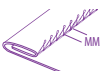









PRICE & INFO



Industrial sewing machines legend

AUTO		THREAD TRIMMER		NEEDLE SYSTEM
		AUTOMATIC BARTACKING		TOTAL NEEDLE GAUGE
		WIPER		SPLIT NEEDLES
		AUTOMATIC PRESSER FOOT LIFTER		PRESSER FOOT LIFT HEIGHT
		AUTOMATIC NEEDLE POSITIONING		LED LAMP
		STARTING STITCH CONTROLLER		THICKNESS OF SEWN FABRIC
	BOTTOM FEED		SEWING SPEED	
	NEEDLE FEED		BUILT-IN MOTOR	
	COMPOUND FEED - BOTTOM AND WALKING FOOT		CLOSED CENTRAL CIRCUIT	
	UNISON FEED		CNC FEED	
	DIFFERENTIAL BOTTOM FEED		BOBBIN SIZE	
	BOTTOM ROLLER FEED AND ROLL PRESSER FOOT			

	STITCH LENGTH
	
	
	
	
	
	STITCH WIDTH
	
	
	DECORATIVE STITCH
	NO. OF PATTERNS
	

	BUTTONHOLE SIZE
	CLAMP SIZE
	KNIFE SIZE
	SYSTEM MULTI-CUT
	BARTACK SIZE
	BUTTON DIAMETER
	SEWING-IN POST BUTTON
	WORKONG AREA
	SKIP STITCH DEVICE
	POST HEIGHT
	POST CIRCUMFERENCE
	NO. OF THRAEDS

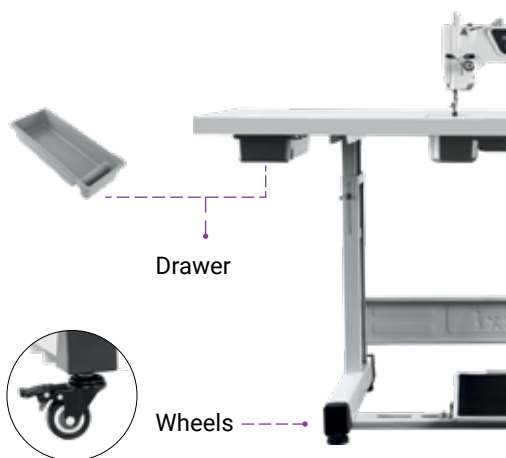

EVERY ELEMENT



HEAD

modern heart of the machine with an energy-efficient and quiet motor – guarantees reliability and high performance



TABLETOP

made of multi-layer plywood, covered with a smooth laminate resistant to impact and abrasion. Equipped with a ruler in inches and centimeters, and a storage compartment for bobbins and needles



Ruler



Storage for spools and needles

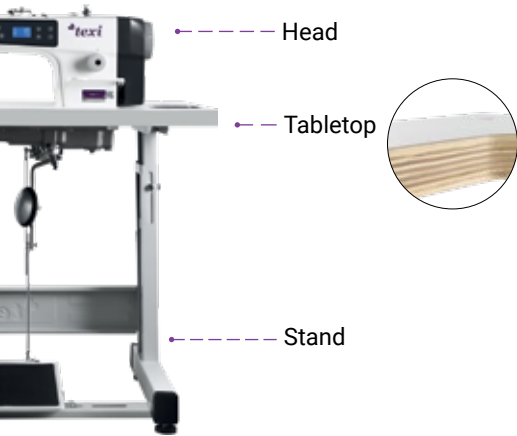

MATTERS



STAND

height adjustable – solid base – stable support, high load capacity and durability. Standard with rubber feet



Lightweight machines



Heavy machines



WHEELS

(optional) durable, swivel castors with brakes





RELIABILITY FOR YEARS TO COME

Texi Future means reliability for years to come. We guarantee it!

Texi Future industrial machines are available with a comprehensive tailor-made warranty package. Choose the best option and enjoy safety and warranty service for up to 4 years.

When you choose Texi Future, you can only choose well, or better.

Unicode our F series code

Example:

TEXI TRONIC



MODEL

TRONIC

TWIN

WALKER

TRE – 3 threads

QUATTRO – 4 threads

CINQUE – 5 threads

ORLO – 3-threads

rolled hem

TRECCIA

TRECCIA-C

CATENACCIO

X

781

0

Q

EXTEND YOUR WARRANTY

UP TO

4 years



7

AUTOMATION LEVELS

- 1** without automation (only needle positioning)
- 3** basic automation (thread trimming, presser foot lifting)
- 5** full automation, open oil pan
- 6** full automation, closed oil circulation, decorative stitch
- 7** full automation, closed oil circulation, decorative stitch

H

SEWN FABRICS

- no symbol** light and medium fabrics
- H** heavy fabrics, large hook

F

SERIES

- F** FUTURE series

NF

TYPE OF FEED

- no symbol** bottom feed
- NF** needle feed









WORK AREA

- 65** work area 60 x 50 mm
- 43** work area 40 x 30 mm

texi Single needle lockstitch machines



BOTTOM FEED

		AUTO						
								
16	TEXI TRONIC 1F	-	-	-	✓	-	-	✓
17	TEXI TRONIC 5F	✓	✓	✓	✓	✓	-	✓
18	TEXI TRONIC 6F	✓	✓	✓	✓	✓	✓	✓



TEXI TRONIC 1F

Single needle lockstitch machine with needle positioning



PRICE & INFO

TEXI TRONIC 5F

Automatic single needle lockstitch machine



PRICE & INFO



TEXI TRONIC 6F

Automatic single needle lockstitch machine with decorative stitch and closed lubrication system











PRICE & INFO

SYSTEM	MM	MM				CM		AC 230 V
135 x 5	5	5,5 - 13	✓	L/M	5 000	26,3	-	550 W
135 x 5	5	5,5 - 13	✓	L/M	5 000	26,3	-	550 W
135 x 5	6	5,5 - 13	✓	L/M	5 000	30,5	✓	550 W

texi Lockstitch machines with needle feed



	AUTO					ART AUTO		
								
TEXI TRONIC 7F NF	✓	✓	✓	✓	✓	✓	✓	135 x 5
TEXI TRONIC 7HF NF	✓	✓	✓	✓	✓	✓	✓	135 x 5



ART
— — —
AUTO



TEXI TRONIC 7F NF

Automatic lockstitch machine with needle feed for light and medium fabrics



PRICE & INFO

TEXI TRONIC 7HF NF









Automatic lockstitch machine with needle feed for heavy fabrics



26 MM



PRICE & INFO

 MM	 MM	 MM				 CM		 AC 230V
5	5,5-13	21	✓	L/M	4 500	26,3	✓	550 W
5	5,5-13	26	✓	M/H	4 000	26,3	✓	750 W

texi Double needle lokstitch machines



TWO NEEDLES



NEEDLE FEED



AUTO

									
17									
18	TEXI TWIN 1F	-	-	-	✓	-	-	✓	135 x 5
19	TEXI TWIN 6HF	✓	✓	✓	✓	-	✓	✓	135 x 5

TEXI TWIN 1F

Double needle lockstitch machine with needle positioning



PRICE & INFO



TEXI TWIN 6HF

Automatic double needle lockstitch machine for heavy fabrics











PRICE & INFO













28 MM



 MM	 MM	 MM				 CM		 AC 230 V
5	7,0 - 10	21	✓	L/M	3 000	25,5	-	550 W
6	7,0 - 10	28	✓	M/H	3 000	26,3	✓	750 W

texi Overlock (safety stitch) machines



	AUTO			 SYSTEM			 MM					 AC 230 V
TEXI TRE 1F	✓	3	✓	B27	0,8-4	0+4	6	✓	L/M	6 000	✓	550 W
TEXI ORLO 1F	✓	3	✓	B27	0,8-4	1,5-3,0	6	✓	L/M	6 000	✓	550 W

TEXI TRE 1F

Overlock 1-needle, 3-thread with automatic needle positioning



PRICE & INFO

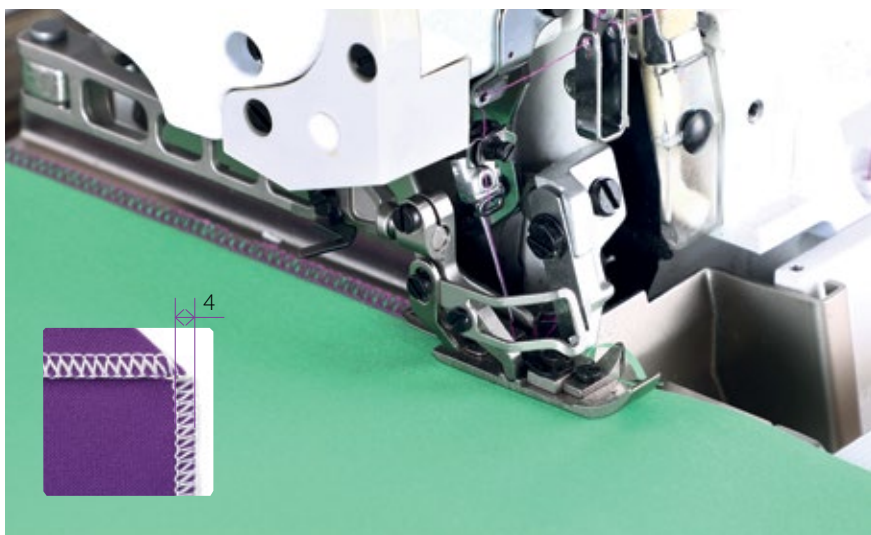

TEXI ORLO 1F

Rolled hem overlock 1-needle, 3-thread with automatic needle positioning



PRICE & INFO

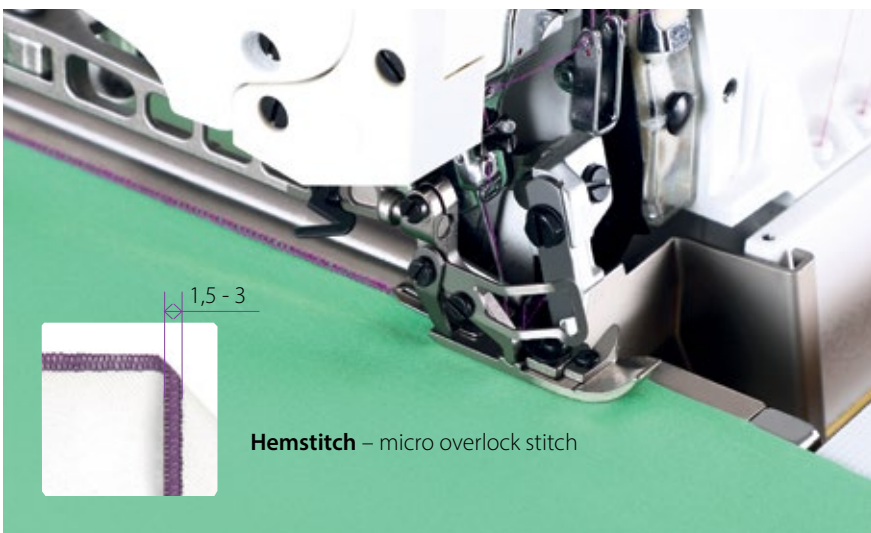

texi® 4- and 5-thread overlock machines

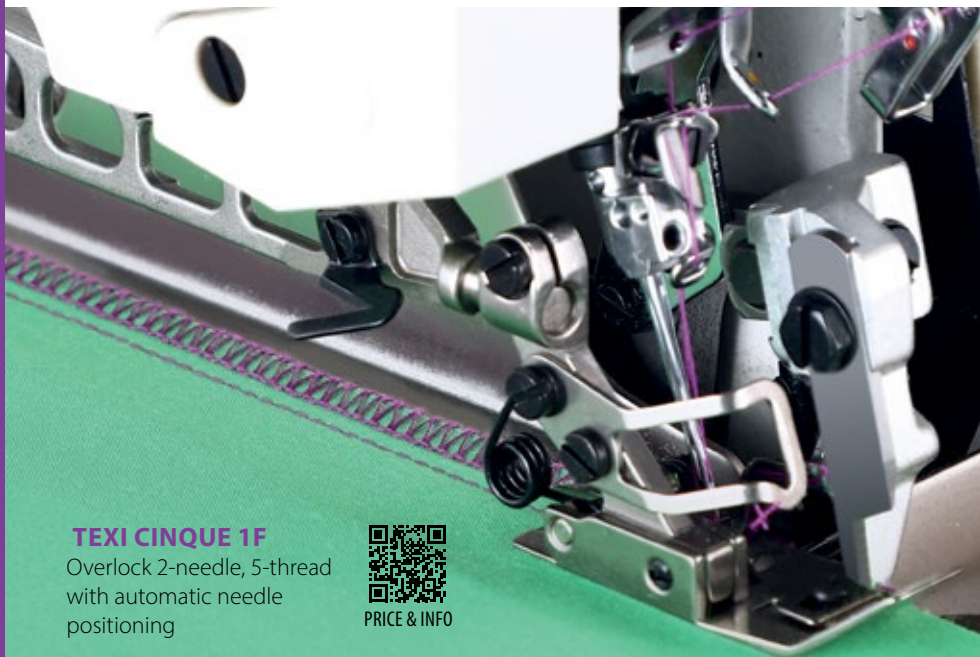

TEXI CINQUE 1F

Overlock 2-needle, 5-thread
with automatic needle
positioning



PRICE & INFO

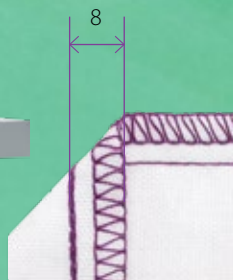

	AUTO						SYSTEM		MM
TEXI QUATTRO 1F	-	-	-	✓	✓	2	B-27	2	
TEXI CINQUE 1F	-	-	-	✓	✓	2	B-27	3	
TEXI QUATTRO 3F	✓	-	✓	✓	✓	2	B-27	2	

TEXI QUATTRO 1F

Overlock 2-needle, 4-thread with automatic needle positioning



PRICE & INFO

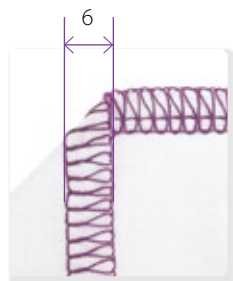









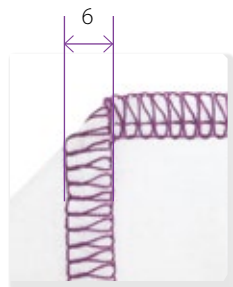

TEXI QUATTRO 3F

Automatic overlock 2-needle, 4-thread with automatic chain cutting, presser foot lifting and needle positioning

















PRICE & INFO



				 MM					 AC 230V
4	0,8 - 4	-	6	6	✓	L/M	6 000	✓	550 W
5	0,8 - 4	8	5	6	✓	L/M	6 000	✓	550 W
4	0,8 - 4	-	6	6	✓	L/M	7 000	✓	550 W

texi Coverstitch (interlock) machines



	AUTO									
										
TEXI TRECCIA 1F	-	-	-	✓	✓	3	UY128	1,2-4	5,6/6,4	
TEXI TRECCIA-C 3F	✓	-	✓	✓	✓	3	UY128	1,2-4	5,6/6,4	

TEXI TRECCIA 1F

Flatbed interlock (coverstitch) 3-needle with automatic needle positioning



FLAT-BED



PRICE & INFO

The set includes a kit that allows you to easily convert the machine to a binding machine.



TEXI TRECCIA-C 3F

Automatic cylinderbed interlock (coverstitch) 3-needle with automatic thread cutting and presser foot lifting













CYLINDER-BED



PRICE & INFO









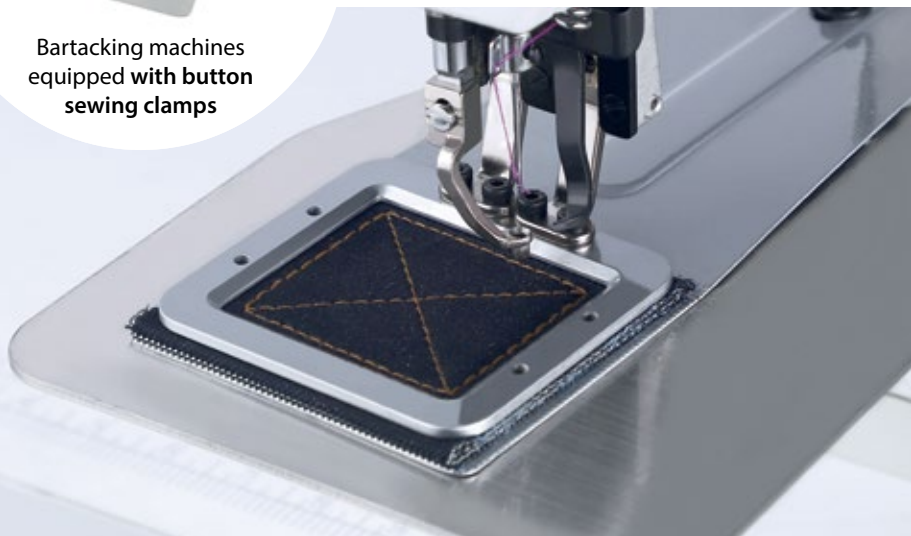

									
5,6 / 6,4	5/4	1.6~4.2 mm	5 - 7	✓	L/M	-	4 500	✓	550 W
5,6 / 6,4	5/4	1.6~4.2 mm	5 - 7	✓	L/M	✓	4 500	✓	550 W

texi Bartacking machines



Bartacking machines equipped with button sewing clamps



	AUTO						
							
TEXI CATENACCIO 43F	✓	✓	✓	✓	✓	40 x 30	✓
TEXI CATENACCIO 65HF	✓	✓	✓	✓	✓	60 x 50	✓

TEXI CATENACCIO 43F

Electronic bartacker
with working area
40 x 30 mm

Clamps included:
12 x 2 mm, 20 x 3.5 mm,
27 x 5 mm, 40 x 30 mm

+
Button sewing clamp



PRICE & INFO

TEXI CATENACCIO 65HF

Electronic bartacker with
working area 60 x 50 mm

Clamps included:
12 x 2 mm, 20 x 3.5 mm,
27 x 5 mm, 60 x 50 mm

+
Button sewing clamp



PRICE & INFO

SYSTEM	MM	MM	MM					AC 230V
135x17	0,1-10	14-17	21	✓	L/M	3 000	✓	550 W
135x5	0,1-10	14-17	21	✓	M/H	2 700	✓	750 W

texi. Button sewing machine

TEXI XF

Electronic cross-stitch
button sewing machine



PRICE & INFO



Patterns from the series



stitches: 8, 16, 32

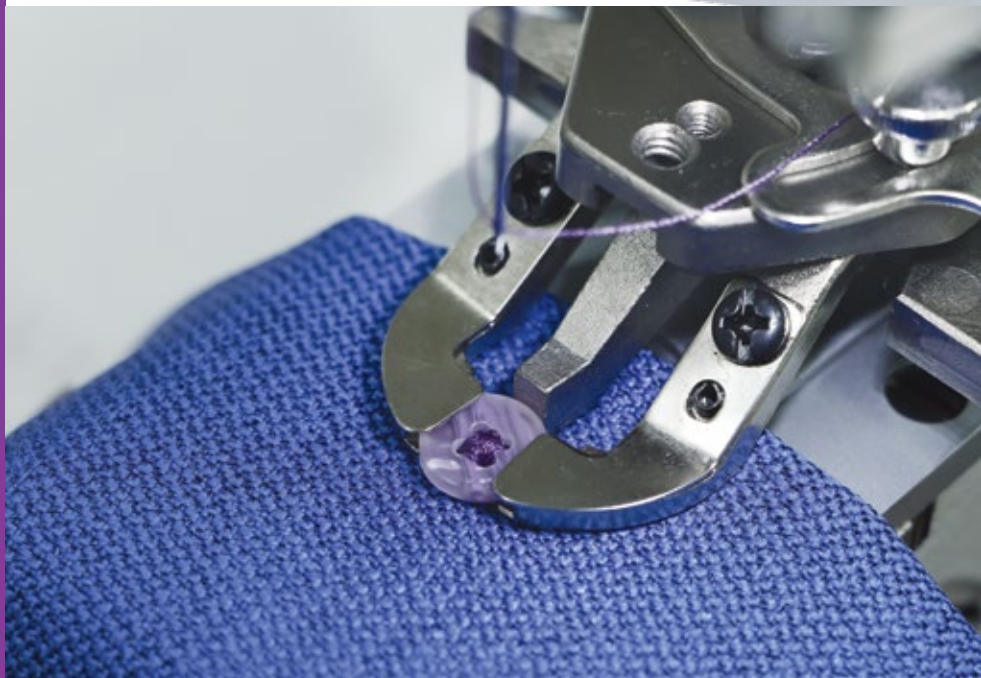

AUTO

✓	✓	✓	TQx1/TQx7	9	10~28	2,5-6,5	OPTION	✓	L/M	1 500	✓	550 W	

texi. Buttonhole machines









TEXI QF

Electronic eyelet
buttonhole machine



PRICE & INFO

	AUTO					 MM	 PATTERNS
							
TEXI QF	✓	✓	✓	✓	✓	30 x 5	30
TEXI 781F	✓	✓	✓	✓	✓	30 x 5	1
TEXI QF	✓	✓	✓	✓	✓	N/A	9

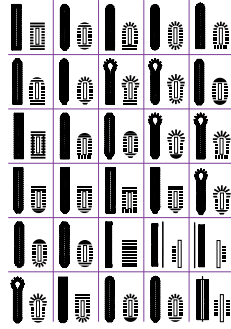

Texi OF



TEXI 781F

Automatic straight buttonhole machine



PRICE & INFO



TEXI OF

Electronic straight buttonhole machine



PRICE & INFO

SYSTEM	MULTI CUT	MM					AC 230 V
135x5	✓	17	✓	L/M	4 200	✓	550 W
135x5	✓	12	✓	L/M	4 000	✓	550 W
558	✓	12 - 16	✓	M/H	2 500	✓	550 W

TEXI ACCURA

Blind stitch machine for light and medium fabrics

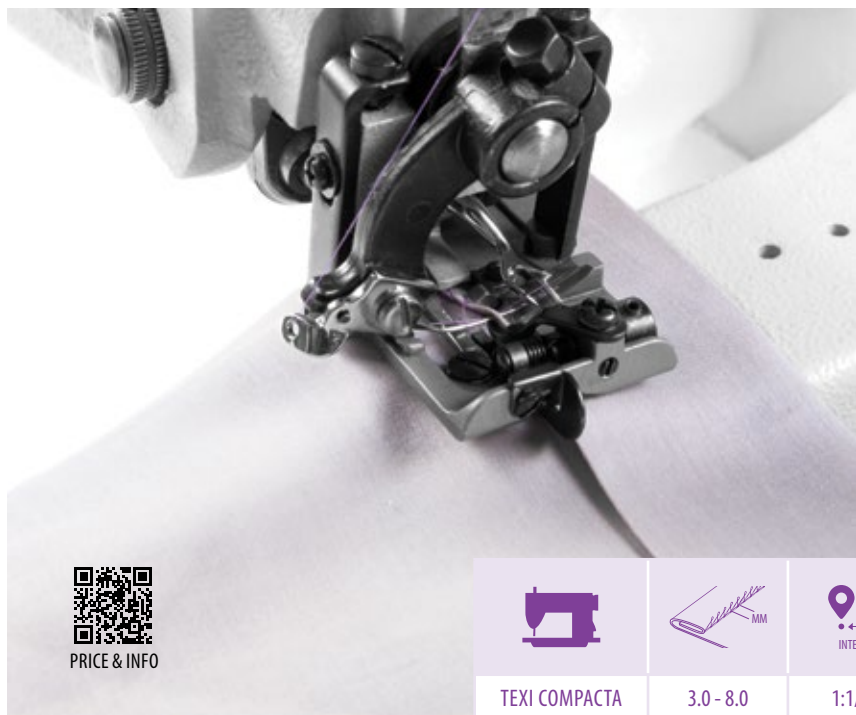

PRICE & INFO

		
TEXI COMPACTA	3.0 - 8.0	1:1/1:2
TEXI ACCURA	3.0 - 8.0	1:1/1:2

TEXI COMPACTA

Portable blind stitch machine for light and medium fabrics



PORTABLE



30 cm



SYSTEM



AC SERVO
230 V

2140 TP

1 200

90 W

2140 TP

2 500

550 W



PRICE & INFO

texi. Multifunctional Machines

TEXI SEP SYSTEM

Multifunctional machine for sewing, embroidering and perforating leather and coated fabrics



PRICE & INFO



WORKING AREA

TEXI SEP System
= 1 200 x 800 mm

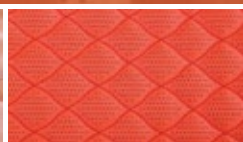
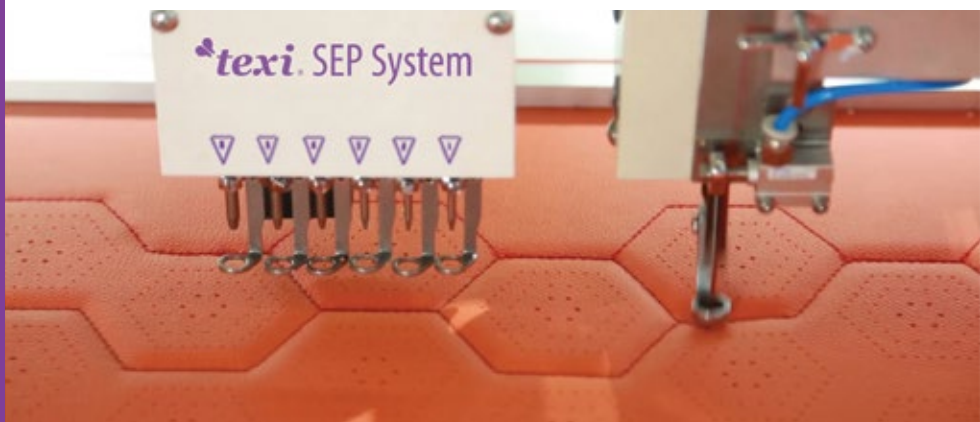

MODEL	TEXI SEP SYSTEM	TEXI SP SYSTEM	TEXI SP 360 SYSTEM
Working area	1 200 x 800 mm		
Bobbin/hook size	XXL / 26 mm		
Max. thread thickness	20		
Sewing	✓		
Sewing: number of needles	1		
Sewing: rotary head	–	–	✓ 360°
Sewing: lifting head	✓ 50 mm		
Max. sewing speed	1 000 stitches/min.	1 000 stitches/min.	1 200 stitches/min.
Feet lifting height	18 mm		
Max. stitch length	12,7 mm		
Embroidering	✓	–	–
Embroidering: number of needles	9	–	–
Max. embroidery speed	850 stitches/min.	–	–
Perforating	✓		
Perforating: number of knives	6		
Perforating: possible knives sizes	0,8 mm, 1,0 mm, 1,2 mm, 1,5 mm, 2,0 mm, 2,5 mm		
Max. speed perforation	800 holes/min.		
Automatic thread trimming	✓		
Broken thread sensor	✓		
Touch panel	✓		
Power supply	230 V or 380 V		
Total power	5,5 kW	5,1 kW	4,5 - 4,8 kW
Starting stitch controller	✓		
LED work area lighting	✓		
Compressed air	✓		

TEXI PERFO DUO

The computer-controlled perforating machine is a key tool for manufacturers of furniture, car upholstery and the clothing industry.



PRICE & INFO

WORKING AREA

TEXI PERFO DUO
= 1 200 x 800 mm

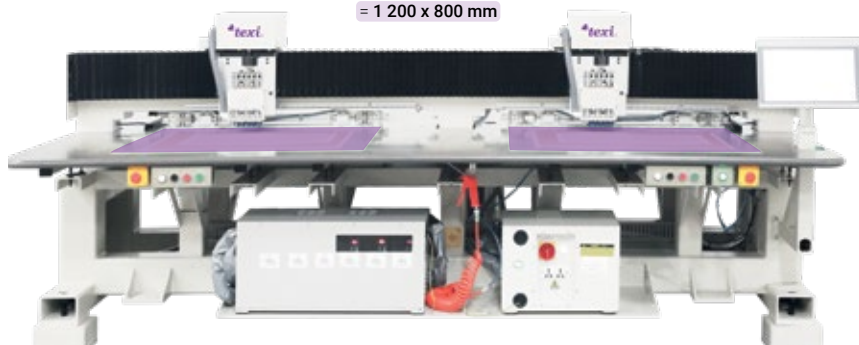

MODEL	TEXI PERFO 1200x800 DUO	TEXI PERFO 900x600 DUO
Working area	2 x 1200 x 800 mm	2 x 900 x 600 mm
Perforating		✓
Perforating: number of knives		6
Perforating: knife sizes included	0,8 mm, 1,0 mm, 1,2 mm, 1,5 mm, 2,0 mm, 2,5 mm	
Max. perforation speed	1 200 holes/min	
Touchpad		✓
Power supply	230 V	
Power	3 kW	
Starting stitch controller		✓
LED work area lighting		✓
Compressed air		✓



MITI *texi* Machines for heavy materials

TEXI FREE 360

Automatic sewing machine for sewing programmable patterns with a precise, rotating sewing head and three independent drives: head, hook and frame.



PRICE & INFO

WORKING AREA

TEXI FREE 360 LF 150X90 SET
= 1 500 x 900 mm

TEXI FREE 360 XLF 250X130 SET
= 2 500 x 1 300 mm

TEXI FREE 360 XXLF 250X150 SET
= 2 500 x 1 500 mm



LARGE WORKING AREA



MODEL	FREE 360 LF 150X90 SET	FREE 360 XLF 250X130 SET	FREE 360 XXLF 250X150 SET
Type of sewn fabric		Thick and difficult	
Working area	1 500 x 900 mm	2 500 x 1 300 mm	2 500 x 1 500 mm
Bobbin/hook size		XXL / 26 mm	
Max. thread thickness		20	
Automatic thread trimming		✓	
Thread breakage sensor		✓	
Touch panel		✓	
LED work area lighting		✓	
Max. sewing speed		3 000 stitch/min.	
Feet Lifting height		22 mm	
Max. stitch length		12,7 mm	
Needle system		135 x 17	
Power supply		230 V	
Rotary head 360		✓	
Engine power		750 W	
Compressed air		✓	

TEXI CNC 250X120

Industrial CNC machine for the mass production of repetitive patterns. Equipped with a direct servo drive and dry-head technology that eliminates the risk of oil stains. A machine designed for use in the automotive and furniture industries, as well as for the production of large textile components.





15" touchscreen – optional

A control panel with remote servicing capabilities and advanced automatic functions ensure efficiency, consistency and the highest stitch quality.



MODEL	TEXI CNC 250X120
Type of sewn fabric	Thick and tough
Work area	2500 x 1200 mm
Size of hook/spool	XXL / 26 mm
Max. thread thickness	20
Automatic thread trimming	✓
Thread break sensor	✓
Touchscreen	✓

LED work area lighting	✓
Max. sewing speed	3 000 stitch/min
Foot lift height	16 mm
Max. stitch length	12,7 mm
Needle system	134 x 35
Power supply	230 V
Engine power	500 W
Compressed air	required

texi Walker

Upholstery and leather lockstitch machines



TEXI WALKER 6F

AUTO



ART
AUTO



SYSTEM

135x5

TEXI WALKER 6F

Automatic lockstitch machine with walking feed, for sewing leather. Ideal for upholstered furniture manufacturers, leather goods makers, leather clothing manufacturers and automotive seat manufacturers. The machine allows for easy adjustment of the walking feed height.











26 MM



PRICE & INFO



MACHINES FOR HEAVY MATERIALS

 MM	 MM	 CM	 MM					 AC230V
10	26	26,3	6-13	✓	M/H	2 800	✓	750 W



PRICE & INFO

mitis *texi*® HD 8

texi® Seria HD 8

Automatic upholstery and leather lockstitch machine with unison feed, bobbin 32 mm

High Presser System

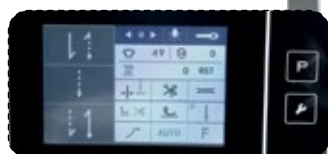

Touch screen



TEXI HD 8-32

Automatic lockstitch machine for upholsterers and leatherworkers



PRICE & INFO



TEXI HD 8-26

Automatic lockstitch machine for upholsterers and leatherworkers



PRICE & INFO

MACHINES FOR HEAVY MATERIALS



AUTO



SYSTEM



MM



MM



MM



AC SERVO
230 V

TEXI HD 8-26

✓ ✓ ✓ ✓ ✓

✓

134 x 35

9

20

✓

M/H

26

3 000

750 W

TEXI HD 8-32

✓ ✓ ✓ ✓ ✓

✓

134 x 35

9

20

✓

M/H

32

3 000

750 W

100 **texi** RAM Series



TEXI RAM B-T
Lockstitch machine
with edge trimmer
and binding device



PRICE & INFO



TEXI RAM R-A
Lockstitch machine with
differential ruffling, for
ruffled seams



PRICE & INFO

TEXI RAM TN
Twin-needle
lockstitch machine



TWO NEEDLES



PRICE & INFO

	AUTO				TWO NEEDLES	MM	
TEXI RAM	-	-	-	✓	-	-	✓
TEXI RAM A	✓	✓	✓	✓	-	-	✓
TEXI RAM TN	-	-	-	✓	✓	12	✓
TEXI RAM B-T	-	-	-	✓	-	-	✓
TEXI RAM R-A	✓	✓	✓	✓	-	-	✓
TEXI RAM L-A	✓	✓	✓	✓	-	-	✓
TEXI RAM TN-L-A	✓	✓	✓	✓	✓	12	✓



TEXI RAM

Single-needle lockstitch machine



PRICE & INFO



TEXI RAM A

Automatic single-needle lockstitch machine



PRICE & INFO



TEXI RAM L-A

Single-needle lockstitch machine with an enlarged workspace



PRICE & INFO

TEXI RAM TN-L-A

Twin-needle lockstitch machine with an enlarged workspace



TWO NEEDLES



WORK AREA
63,5 CM



PRICE & INFO

SYSTEM	CM	MM	MM	MM			AC SERVO 230V
134 - 35	25,5	28	9	16	M/H	2 500	800 W
134 - 35	33,5	28	9	16	M/H	2 500	800 W
134 - 35	25,5	28	9	16	M/H	2 000	800 W
134 - 35	25,5	28	9	16	M/H	2 000	800 W
134 - 35	25,5	28	9	16	M/H	2 000	800 W
134 - 35	63,5	28	9	16	M/H	2 000	800 W
134 - 35	63,5	28	9	16	M/H	2 000	800 W



TWO NEEDLES

TEXI RAM TN-P

Post-bed twin-needle sewing machine



PRICE & INFO

















TWO NEEDLES

TEXI RAM TN-P-A

Automatic post-bed twin-needle sewing machine



PRICE & INFO

 TEXI RAM TN-P TEXI RAM TN-P-A	AUTO				 TWO NEEDLES	 SYSTEM	 CM	 MM	 MM	 MM					
															
TEXI RAM TN-P	-	-	✓	-	✓	✓	134 - 35	16	26	9	16	✓	M/H	2 000	800 W
TEXI RAM TN-P-A	✓	✓	✓	✓	✓	✓	134 - 35	16	26	9	16	✓	M/H	2 000	800 W



TEXI RAM C

Single-needle cylinder bed sewing machine



PRICE & INFO

















TEXI RAM C-A

Automatic single-needle cylinder bed sewing machine



PRICE & INFO

 TEXI RAM C TEXI RAM C-A	AUTO				 TWO NEEDLES	 SYSTEM	 CM	 MM	 MM	 CYLINDER-BED				
														
TEXI RAM C	-	-	-	✓	✓	✓	134 - 35	25,5	9	16	✓	M/H	2 500	800 W
TEXI RAM C-A	✓	✓	✓	✓	✓	✓	134 - 35	25,5	9	16	✓	M/H	2 500	800 W

TEXI POST DD PREMIUM

Post-bed lockstitch machine with bottom, needle and upper roller feed



PRICE & INFO



MACHINES FOR HEAVY MATERIALS

AUTO														
						SYSTEM	CM ↓		MM	MM				
✓	✓	-	✓	✓	✓	135 x 5	17	21 mm	4.5	8	✓	M/H	3 000	750 W

info@mitis.lt







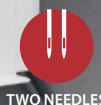

TEXI NOVA P-OS 3212

Automatic post bed double-needle sewing machine featuring decorative stitch



PRICE & INFO



	AUTO				 TWO NEEDLES	 MM	
							
TEXI NOVA 2609	✓	✓	✓	✓	-	-	✓
TEXI NOVA 3212	✓	✓	✓	✓	-	-	✓
TEXI NOVA TN 3212	✓	✓	✓	✓	✓	12	✓
TEXI NOVA P-OS 3212	-	✓	✓	✓	✓	8	✓

TEXI NOVA 2609

Single-needle automatic upholstery sewing machine. Large bobbin 26 mm



High Presser System



XXL



TWO NEEDLES

TEXI NOVA 3212

Single-needle automatic upholstery sewing machine. Large bobbin 32 mm



TEXI NOVA TN 3212

Twin-needle automatic upholstery sewing machine



MACHINES FOR HEAVY MATERIALS

SYSTEM	MM	MM	CM	MM				AC SERVO 230 V
134 - 35	26	16	35,1	9	✓	M/H	3 400	800 W
134 - 35	32	16	35,1	12	✓	H/XH	3 400	800 W
134 - 35	32	16	35,1	12	✓	H/XH	3 400	800 W
134 - 35	32	16	35,5	12	✓	H	800	800 W

texi Embroidery machines

Operation training
and delivery included
in the price



TEXI 1501 XL TS

Industrial compact
embroidery machine
15-needle

- Max. embroidery area
600 x 400 mm
- Sewing speed
1,000 stitches/min.
- Touch panel, WiFi
connection
- 11 hoops (6 sizes)
- Hats, flat embroidery
and more



PRICE & INFO



TEXI IRIS 12 HOOP

Rectangular embroidery hoop for embroidering on thick fabrics, 300 x 200 mm



PRICE & INFO

TEXI IRIS 12 TABLE

Stabilising table makes it easier to embroider larger areas



PRICE & INFO

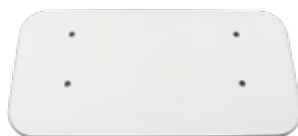

TEXI IRIS 12

Industrial compact embroidery machine
12-needle

- Embroidery area 300 x 200 mm
- Sewing speed 1.000 stitches/min.
- Touch panel
- 4 hoops (4 different sizes)
- Hats, flat embroidery and more



PRICE & INFO

texi Dress form



TEXI DRESS FORM 36-42 TEXI DRESS FORM 42-48



PRICE & INFO

ADJUSTMENT RANGE	36 - 42	42 - 48
neck	35 - 46 cm	35 - 46 cm
bust	84 - 100 cm	101 - 117 cm
waist	64 - 80 cm	77 - 97 cm
hip	86 - 102 cm	102 - 119 cm

texi Uniwersalne lampki LED

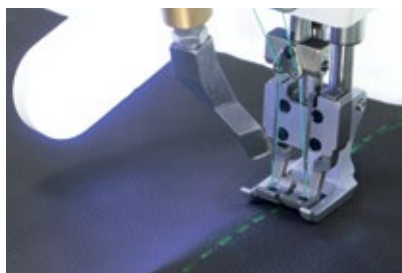

TEXI LED DUO

Universal 2-in-1 LED lamp with UV function



PRICE & INFO



TEXI LED TOUCH

Universal LED lamp with magnetic mount



PRICE & INFO

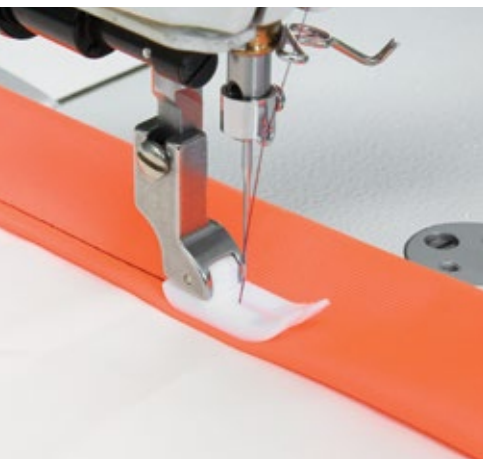

TEXI 5001
Foot for sewing leather
and other difficult
materials



PRICE & INFO

TEXI 4003
Pin for quick
foot fixing



PRICE & INFO



TEXI 5004
PTFE foot
with rings



PRICE & INFO

TEXI 5006
Double hemming foot
1/8" (3.2 mm)



PRICE & INFO

1
2
3
4
5
6
7
8
9
10
11
12
13
14
15
16
17
18
19

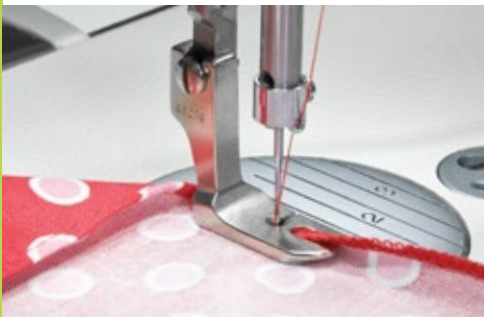

TEXI 5007

Single hemming foot
1/8" (3.2 mm)



PRICE & INFO



TEXI 5010

Adjustable
shirring foot



PRICE & INFO



Cording foot, narrow

TEXI 5008

Left



PRICE & INFO

TEXI 5009

Right



PRICE & INFO



TEXI 5011

Zipper foot



PRICE & INFO

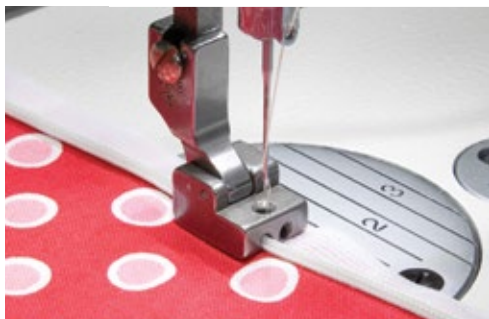

TEXI 5012

Invisible zipper
foot



PRICE & INFO

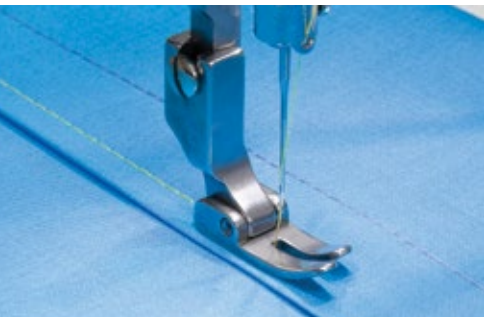

TEXI 5013
Standard foot



PRICE & INFO



TEXI 5014
Roller foot
for difficult fabrics



PRICE & INFO

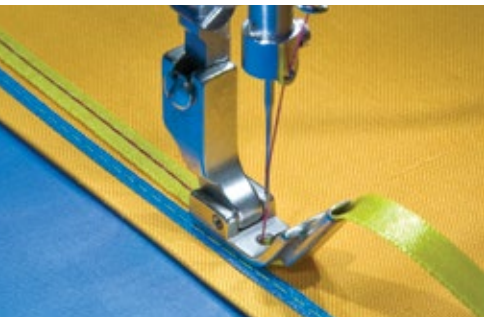

TEXI 5015
Foot with central tape
guide 4.8 mm



PRICE & INFO



TEXI 5020
Piping foot
3.2 mm, left



PRICE & INFO



Compensating foot 1.0 mm

TEXI 5016
Right



PRICE & INFO

TEXI 5017
Left



PRICE & INFO

1
2
3
4
5
6
7
8
9
10
11
12
13
14
15
16
17
18
19



Compensting PTFE coated foot, 1.0 mm

TEXI 5018

Right



PRICE & INFO

TEXI 5019

Left



PRICE & INFO



TEXI 5021

Foot for hemmer



PRICE & INFO



TEXI 5022

Foot for fine fabrics



PRICE & INFO



TEXI 5023

Foot for heavy fabrics



PRICE & INFO



TEXI 6001

Right angle bias binder 30/8 mm



PRICE & INFO

8 mm



TEXI 6002
Tape binder
5/8" (16/8 mm)



PRICE & INFO

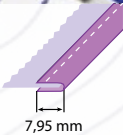

7,95 mm



TEXI 6003
Swing hemmer
3/8" (9.53 mm)



PRICE & INFO



9,53 mm



TEXI 4004
Universal screw for
binders, hemmers
and gauges (2 pcs)



PRICE & INFO



TEXI 4009
Magnetic
gauge



PRICE & INFO

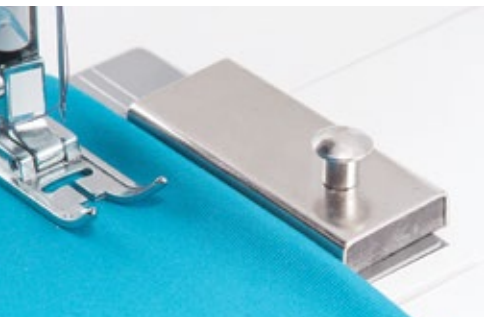

TEXI 4010
Magnetic gauge -
long (50 mm) and
very strong



PRICE & INFO



TEXI 4021
Sewing gauge



PRICE & INFO

texi Needles for industrial sewing machines



PRICE & INFO

POINT TYPES FOR KNITTED AND WOVEN FABRICS

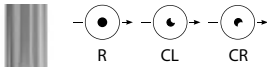

Normal round point

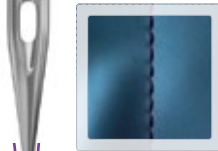

Acute round point



Light ball point



Medium ball point



Heavy ball point



Special ball point

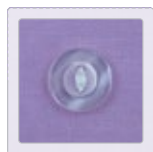

Heavy rounded point for sewing on buttons

POINT TYPES (BLADES) FOR LEATHER

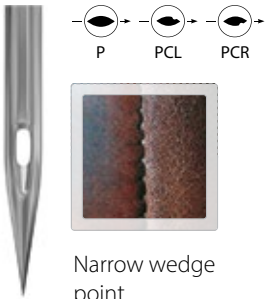

Narrow wedge point

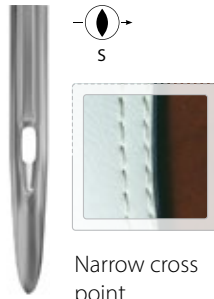

Narrow cross point

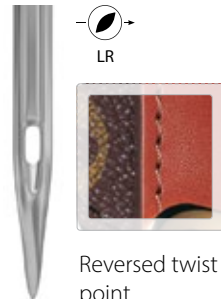

Reversed twist point

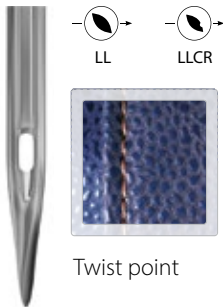

Twist point



Diamond point

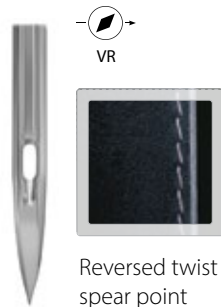

Reversed twist spear point

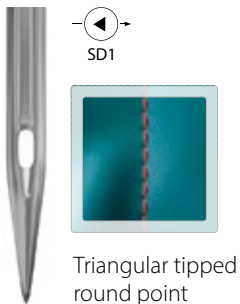

Triangular tipped round point

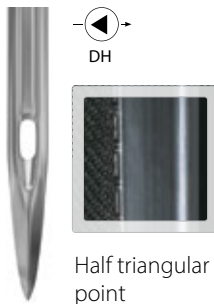

Half triangular point

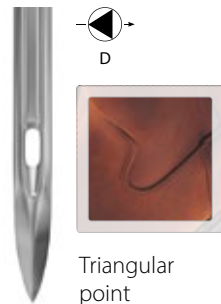

Triangular point



texi. Needles for household sewing machines

EASY WITH COLOR NEEDLE TYPE

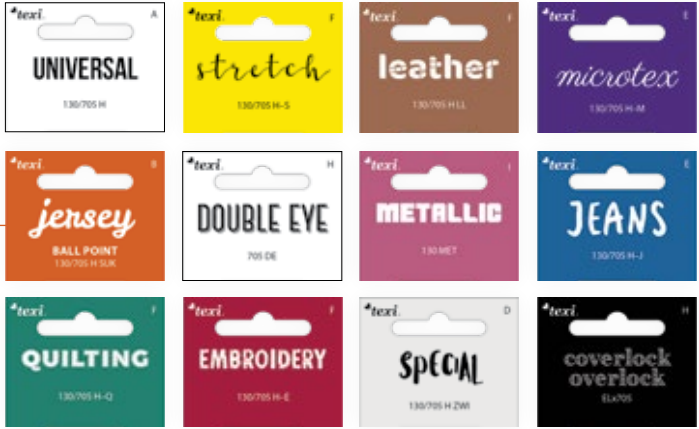

NEEDLE SIZE IN MM

NEEDLES FOR HOUSEHOLD SEWING MACHINES

texi Needles for household sewing machines

TEXI UNIVERSAL

Universal needle for most fabrics, also jersey, synthetics etc.



PRICE & INFO

	UNIVERSAL 130/705 H 5x60
	UNIVERSAL 130/705 H 5x70
	UNIVERSAL 130/705 H 5x80
	UNIVERSAL 130/705 H 5x90
	UNIVERSAL 130/705 H 5x100
	UNIVERSAL 130/705 H 5x110
	UNIVERSAL 130/705 H 5x120
	UNIVERSAL 130/705 H 2x70, 2x80, 1x90
	UNIVERSAL 130/705 H 1x70, 2x80, 1x90, 1x100
	UNIVERSAL 130/705 H 10x70
	UNIVERSAL 130/705 H 10x80
	UNIVERSAL 130/705 H 10x90
	UNIVERSAL 130/705 H 10x100
	UNIVERSAL 130/705 H 2x70, 3x80, 3x90, 2x100
	UNIVERSAL 130/705 H 10x60-110



TEXI STRETCH

Stretch needle for elastic materials and highly elastic knitwear.



PRICE & INFO

	STRETCH 130/705 H-S 5x65
	STRETCH 130/705 H-S 5x75
	STRETCH 130/705 H-S 5x90
	STRETCH 130/705 H-S 3x75, 2x90



TEXI JERSEY

Ball point needles (medium ball) for household machines.



PRICE & INFO

	JERSEY 130/705 H SUK 5x70
	JERSEY 130/705 H SUK 5x80
	JERSEY 130/705 H SUK 5x90
	JERSEY 130/705 H SUK 5x100
	JERSEY 130/705 H SUK 2x70, 2x80, 1x90



TEXI JEANS

Jeans needle for tightly woven fabrics.



PRICE & INFO

	JEANS 130/705 H-J 5x70
	JEANS 130/705 H-J 5x80
	JEANS 130/705 H-J 5x90
	JEANS 130/705 H-J 5x100
	JEANS 130/705 H-J 5x110
	JEANS 130/705 H-J 2x90, 2x100, 1x110

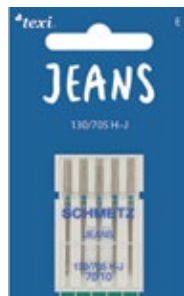

TEXI LEATHER

Leather needle with cutting point for leather, imitation leather and similar fabrics. Not suitable for textiles.



PRICE & INFO

	LEATHER 130/705 H LL 5x70
	LEATHER 130/705 H LL 5x80
	LEATHER 130/705 H LL 5x90
	LEATHER 130/705 H LL 5x100
	LEATHER 130/705 H LL 5x110
	LEATHER 130/705 H LL 5x120
	LEATHER 130/705 H LL 2x80, 2x90, 1x100



TEXI MICROTEx

Microtex needle for silk, microfibre fabrics, coated fabrics and foils.



PRICE & INFO

	MICROTEx 130/705 H-M 5x60
	MICROTEx 130/705 H-M 5x70
	MICROTEx 130/705 H-M 5x80
	MICROTEx 130/705 H-M 5x90
	MICROTEx 130/705 H-M 2x60, 2x70, 1x80



TEXI QUILTING

Special needle for quilting and patchwork.



PRICE & INFO

	QUILTING 130/705 H-Q 5x75
	QUILTING 130/705 H-Q 5x90
	QUILTING 130/705 H-Q 3x75, 2x90



TEXI EMBROIDERY

Special needle for embroidering with voluminous threads and woollen threads.



PRICE & INFO

- EMBROIDERY 130/705 H-E 5x75
- EMBROIDERY 130/705 H-E 5x90
- EMBROIDERY 130/705 H-E 3x75, 2x90

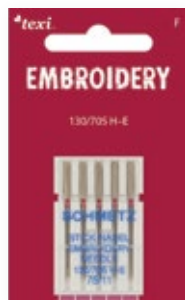

TEXI METALLIC

Metallic needle for trouble free sewing with sensitive metallic decorative threads.



PRICE & INFO

- METALLIC 130 MET 5x80
- METALLIC 130 MET 5x90

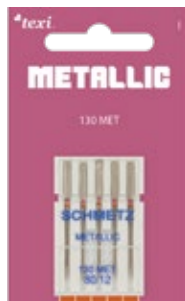

TEXI DOUBLE EYE

Double eye needle for topstitching with decorative threads.



PRICE & INFO

- DOUBLE EYE 705 DE 5x80



TEXI UNIVERSAL TWIN

Twin needle for decorative stitch.

Only for use on zig-zag-machines with transversal hook.



PRICE & INFO

- UNIVERSAL TWIN 130/705 H ZWI NE 2,0-80
- UNIVERSAL TWIN 130/705 H ZWI NE 2,5-80
- UNIVERSAL TWIN 130/705 H ZWI NE 3,0-90
- UNIVERSAL TWIN 130/705 H ZWI NE 4,0-80
- UNIVERSAL TWIN 130/705 H ZWI NE 4,0-90
- UNIVERSAL TWIN 130/705 H ZWI BR NE 6-100
- UNIVERSAL TWIN 130/705 H ZWI BR NE 8-100

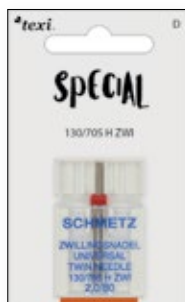

TEXI COVERLOCK OVERLOCK

Needle for overlock and coverlock machine.



PRICE & INFO



OVERLOCK/COVERLOCK ELX705 5x80
OVERLOCK/COVERLOCK ELX705 5x90
OVERLOCK/COVERLOCK ELX705 CF 5x65
OVERLOCK/COVERLOCK ELX705 CF 5x80
OVERLOCK/COVERLOCK ELX705 CF 5x90
OVERLOCK/COVERLOCK ELX705 SUK CF 5x65
OVERLOCK/COVERLOCK ELX705 SUK CF 5x80
OVERLOCK/COVERLOCK ELX705 SUK CF 5x90



TEXI CREATIVE 5

Needles for household machines MIX, 5 pcs



PRICE & INFO

TEXI CREATIVE 9+

Needles for household machines MIX, 9 pcs



PRICE & INFO

TEXI CREATIVE 10

Needles for household machines MIX, 10 pcs



PRICE & INFO

info@mitis.lt



PRICE & INFO

TEXI JOY 13

Multifunctional sewing machine, 13 stitches



13 STITCHES

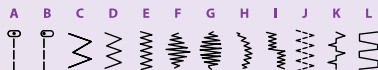

4 STEP
BUTTONHOLE



5 YEARS WARRANTY

SAFE FOR A CHILD

THE BEST TO START

MAIN FUNCTIONS:

- 13 built-in stitches (including straight, zig-zag and decorative stitches)
- 4-step buttonhole
- Regulation of stitch length (max 3,6 mm) and width (max 4 mm)
- Backward sewing
- Maximum sewing speed 650 s.p.m
- Snap-on feet – SYSTEM MATIC
- Easy threading
- Free arm for circular sewing
- LED lamp
- Thread cutter
- Shuttle hook

EQUIPPED WITH:

standard foot, buttonhole foot, 2 bobbins, needle set, seam ripper, spool pin cap, oiler, soft cover



Free arm for circular sewing

enjoy
YOUR COLOR!



OPTION

TEXI JOY 13 EXTENSION TABLE

Table dimensions: 22,5 cm x 32 cm



PRICE & INFO



info@mitis.lt

TEXI FOX 25

Multifunctional sewing machine, 25 stitches

5 YEARS WARRANTY



PRICE & INFO



EQUIPPED WITH:

standard foot, zipper foot, buttonhole foot, presser foot for sewing buttons, hem guide, 3 bobbins, needle set, seam ripper/brush, multifunction screwdriver, foot controller, oiler, soft cover.

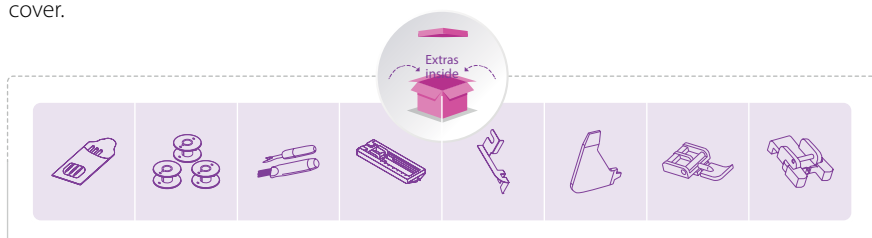

MAIN FUNCTIONS:

- 25 built-in stitches (including straight, zig-zag and decorative)
- 4-step buttonhole
- Regulation of stitch length (max. 4 mm) and width of zig-zag stitch type (max. 4 mm)
- Presser foot lifting height 5,5 mm
- Backwards sewing
- Maximum sewing speed 700 s.p.m.
- Snap-on feet - SYSTEM MATIC
- Free arm for circular sewing
- LED lamp
- Thread cutter
- Shuttle hook
- Needle threader

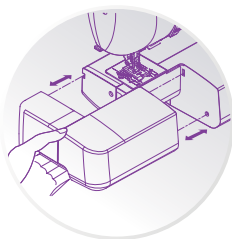
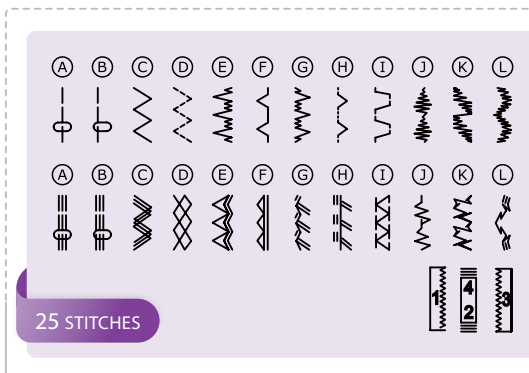

Contains a set of snap-on feet SYSTEM MATIC

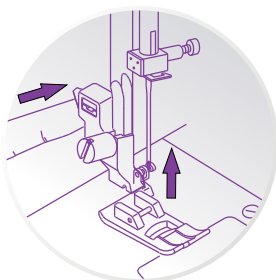

REMEMBER ABOUT:

TEXI FOX 25 EXTENSION TABLE

Table enlarging the working area, dimensions: 36 cm x 26 cm.



PRICE & INFO

info@mitis.it



TEXI JOY 48

Multifunctional mechanical sewing machine, 48 stitches

5 YEARS WARRANTY



PRICE & INFO



EQUIPPED WITH:

Standard foot, zipper foot, buttonhole foot, embroidery plate, hem guide, 3 bobbins, needle set, seam ripper, brush, screwdriver, foot controller, oiler, soft cover

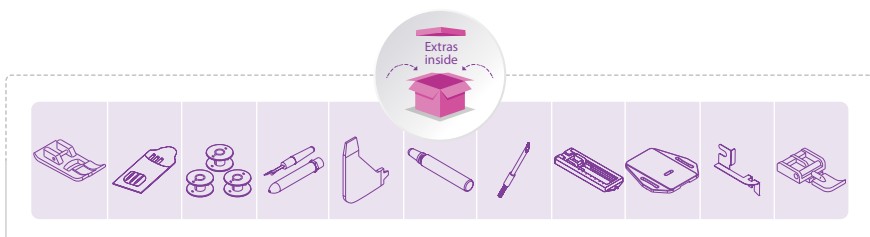

MAIN FUNCTIONS:

- 48 built-in stitches (including straight, zig-zag and decorative)
- 4-step buttonhole
- Regulation of stitch length (max 4 mm) and width (max 5 mm)
- Electronic stitch selection and regulation of stitch width
- Needle positioning button
- Presser foot lifting height 5,5 mm
- Backwards sewing
- Maximum sewing speed 700 s.p.m
- Snap-on feet – SYSTEM MATIC
- Free arm for circular sewing
- Lamp (LED)
- Thread cutter
- Shuttle hook



Free arm for circular sewing

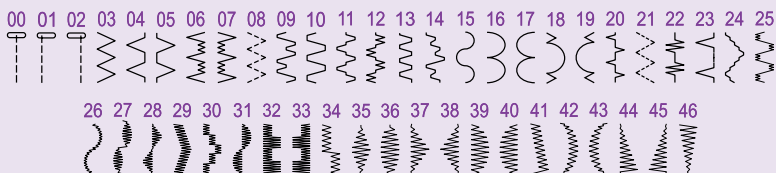
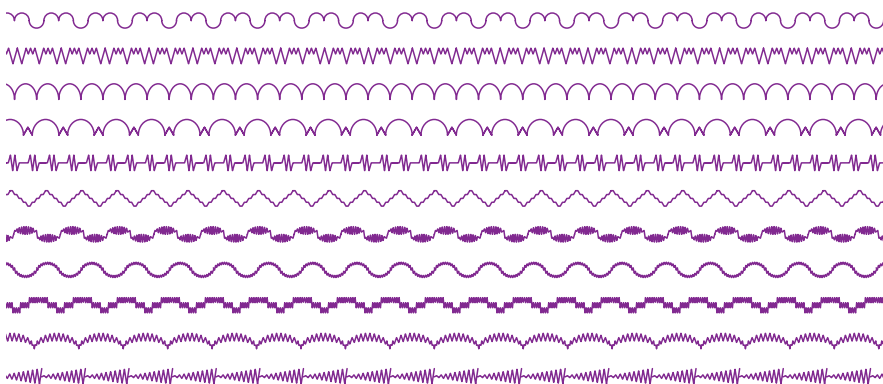

48 STITCHES



STEP
BUTTONHOLE

TEXI BLACK&WHITE

Multifunctional, computerized sewing machine

5 YEARS
WARRANTY

THE BEST EXTRAS
AS STANDARD

200
PROGRAMS



PRICE & INFO



Equipped with:

set of needles, double needle, bobbins, ripper/ Brush, screwdriver for needle plate, spool pin cap, small screwdriver, auxiliary spool pin, satin stitch foot, zipper foot, blind stitch foot, button foot, buttonhole foot, foot controller.



MAIN FUNCTIONS:

- 200 Sewing programs (including 9 types of buttonhole, straight, zig-zag, overlock and decorative stitches)
- Alphabet font
- Smooth regulation of stitch length (max. 4,5 Mm) and width (max. 7 mm)
- Backwards sewing
- Double needle sewing
- Maximum sewing speed 750 s.p.m.
- Electronic sewing speed regulation
- Lcd control panel
- Start/stop button
- Slow start button
- Needle positioning (top/bottom)
- Needle threader

free arm
for circular
sewing



- Snap-on feet - matic system
- Free arm for circular sewing
- Led lamp
- Rotary hook
- Metal componenets
- Drop feed lever

OPTION

TEXI BLACK&WHITE EXTENSION TABLE

Table dimensions: 42 cm x 29 cm



PRICE & INFO

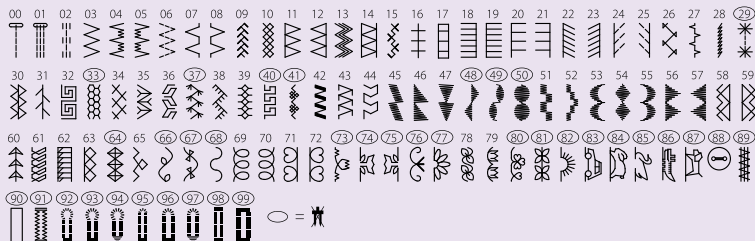

00 01 02 03 04 05 06 07 08 09 10 11 12 13 14 15 16 17 18 19 20 21 22 23 24 25 26 27 28 29
 0 1 2 3 4 5 6 7 8 9 A B C D E F G H I J K L M N O P Q R S T U V W X Y Z a b c d e f
 g h i j k l m n o p q r s t u v w x y z @ ! ? & □ ' " , . - / : ; A A E a a e e
 84 85 86 87 88 89 90 91 92 93 94 95 96 97 98 99
 è é ç œ ð ï ñ ò ó ô õ ö ù ü

200 STITCHES

TEXI BALLERINA SET

Computerized sewing machine, 200 stitch programs



PRICE & INFO

MAIN FUNCTIONS:

- 200 stitch programs including alphabet font
- Smooth regulation of stitch length (max 5 mm) and width (max 7 mm)
- Backwards sewing
- Maximum sewing speed 750 s.p.m
- Electronic sewing speed regulation
- Buttons: pattern clear/erase function (CL), pattern memory function (ME), mirror stitches (MI), pattern repeating (RE), Start/ Stop, Slow Start
- Needle positioning (top/bottom)
- Sewing "stitch by stitch"
- Adjustable presser foot pressure
- Drop feed lever
- Snap-on feet - MATIC SYSTEM
- Free arm for circular sewing



How to easily sew a ballerina skirt?



Download a free tutorial



EQUIPPED WITH:

extension table, LED lamp, thread cutter, needle threader, seam ripper with brush, 4 bobbins, spool pin cap (small and big), set of screwdrivers, set of feet

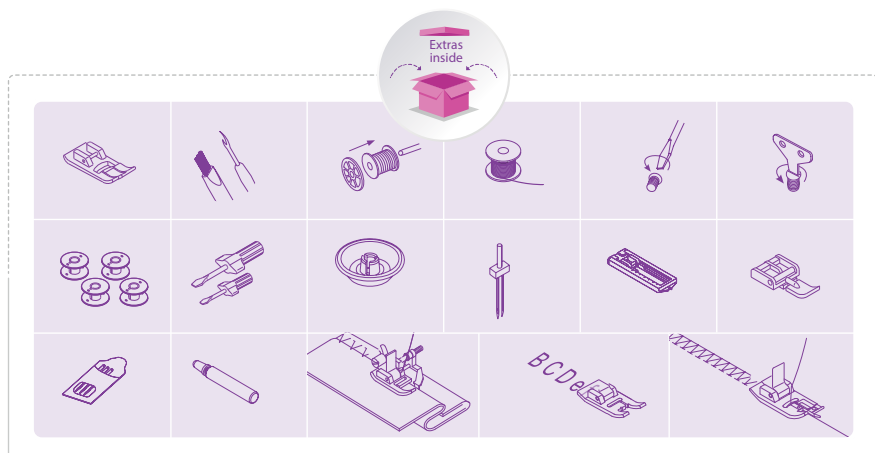



5 YEARS WARRANTY

THE BEST EXTRAS AS STANDARD

200 PROGRAMS

001	002	003	004	005	006	007	008	009	010	011	012	013	014	015	016	017	018	019	020	021	022	023	024	025
026	027	028	029	030	031	032	033	034	035	036	037	038	039	040	041	042	043	044	045	046	047	048	049	050
051	052	053	054	055	056	057	058	059	060	061	062	063	064	065	066	067	068	069	070	071	072	073	074	075
076	077	078	079	080	081	082	083	084	085	086	087	088	089	090	091	092	093	094	095	096	097	098	099	100
101	102	103	104	105	106	107	108	109	110	111	112	113	114	115	116	117	118	119	120	121	122	123	124	125
126	127	128	129	130	131	132	133	134	135	136	137	138	139	140	141	142	143	144	145	146	147	148	149	150
151	152	153	154	155	156	157	158	159	160	161	162	163	164	165	166	167	168	169	170	171	172	173	174	175
U	V	W	X	Y	Z	,	?	&	a	b	c	d	e	f	g	h	i	j	k	l	m	n	o	
176	177	178	179	180	181	182	183	184	185	186	187	188	189	190	191	192	193	194	195	196	197	198	199	200
p	q	r	s	t	u	v	w	x	y	z	[/	.	-	0	1	2	3	4	5	6	7	8	9

200 STITCHES

TEXI BRO

Multifunctional sewing machine, 24 stitches

5 YEARS
WARRANTY

AUTO
THREADING

EASY TO SEW
THICK
MATERIAL



PRICE & INFO

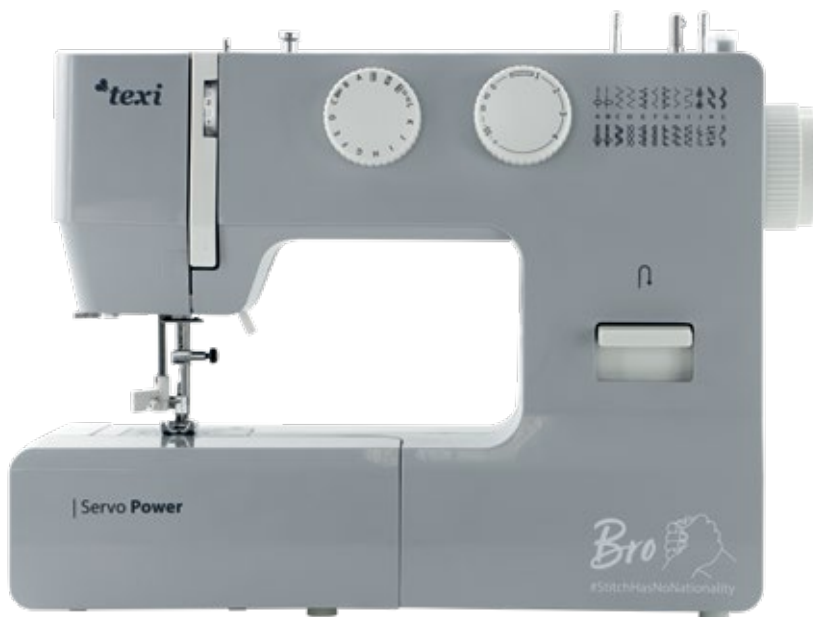

EQUIPPED WITH:

Set of 3 needles + double needle, multifunction screwdriver, bobbins (3pcs), embroiderer plate, seam ripper/brush, button foot, guide, zipper foot, buttonhole foot.



REVOLUTION IN SEWING MACHINES

Servo motor – more power and energy



MAIN FUNCTIONS:

- AC Servo motor
- 24 built-in stitches (including straight, zig-zag and decorative)
- 4-step buttonhole
- Regulation of stitch length (max. 3,6 mm) and width of zig-zag stitch type (max. 4 mm)
- Presser foot lifting height 5 mm
- Backwards sewing
- Maximum sewing speed 750 s.p.m.
- Snap-on feet - SYSTEM MATIC
- Free arm for circular sewing
- LED lamp
- Thread cutter
- Shuttle hook
- Needle threader



Video



Free arm for circular sewing

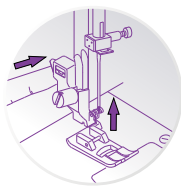

Contains a set of snap-on feet SYSTEM MATIC

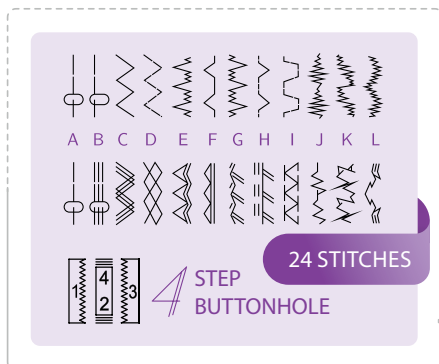

TEXI GOLD

Multifunctional sewing machine, 24 stitches

5 YEARS
WARRANTY

AUTO
THREADING

EASY TO SEW
THICK
MATERIAL



PRICE & INFO



EQUIPPED WITH:

Set of 3 needles + double needle, multifunction screwdriver, bobbins (3pcs), embroiderer plate, seam ripper/brush, button foot, guide, zipper foot, buttonhole foot.



Gold | Servo Power



REVOLUTION IN SEWING MACHINES

Servo motor – more power and energy

MAIN FUNCTIONS:

- AC Servo motor
- 24 built-in stitches (including straight, zig-zag and decorative)
- 4-step buttonhole
- Regulation of stitch length (max. 3,6 mm) and width of zig-zag stitch type (max. 4 mm)
- Presser foot lifting height 5 mm
- Backwards sewing
- Maximum sewing speed 750 s.p.m.
- Snap-on feet - SYSTEM MATIC
- Free arm for circular sewing
- LED lamp
- Thread cutter
- Shuttle hook
- Needle threader



Free arm for circular sewing

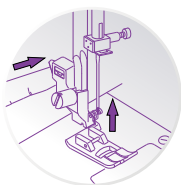

Contains a set of snap-on feet SYSTEM MATIC

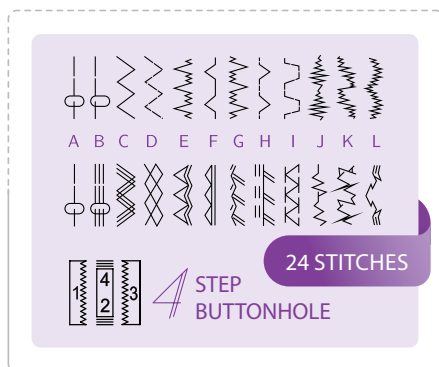

TEXI FORCE

Automatic multifunctional sewing machine with powerful energy-saving AC Servo motor, 23 sewing programmes

5 YEARS WARRANTY

ADJUSTABLE FOOT PRESSURE

FOR THICK MATERIALS



PRICE & INFO



EQUIPMENT

Feet for various applications (universal, for zippers, buttons, buttonholes, anti-skipping), buttonhole cutter with brush, needle set, bobbins, additional thread pin, screwdriver, soft cover



KEY FEATURES

- Energy-saving AC Servo motor, speed sewing speed up to 800 s.p.m.
- 23 sewing programmes (e.g. straight stitches, stretch stitches, blind hems, button sewing)
- Adjustable length (0,5 mm - 4 mm) and stitch width (0 mm - 6 mm)
- Adjustable foot pressure
- Needle threader
- Rotary hook
- Snap-on feet fixing - MATIC SYSTEM
- 7-teeth feed dog
- Drop feed dog
- Extra-high presser foot lift
- Free arm
- LED lighting
- Thread cutter

Force | Servo Power



THE SEWING MACHINE REVOLUTION

Servo motor for more power and energy



Adjustable pressure foot - smooth guidance thin and thick materials

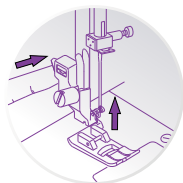

MATIC SYSTEM quick-change feet

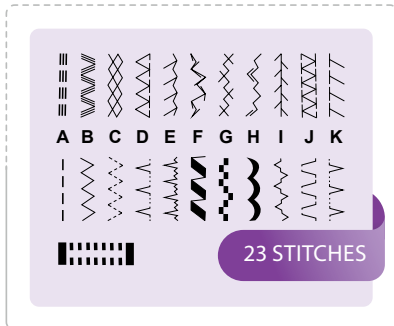

TEXI TANGO

Multifunctional computerised sewing machine with 180 sewing programmes

5 YEARS OF WARRANTY

AUTOMATIC THREAD TRIMMING

180 PROGRAMMES



PRICE & INFO



EQUIPMENT

Feet for various applications (e.g. universal, for zips, for buttonholes, overlock, blind stitch), bobbins (4), needle set, ripper and cleaning brush, screwdriver, thread bobbin holder, machine cover, foot control (pedal)



KEY FEATURES

- 180 editable and customisable stitch programmes, alphabet
- One-step automatic buttonhole
- Needle positioning (up and down)
- Smooth adjustment of stitch length (up to 5 mm) and width (up to 7 mm)
- Built-in 7-inch LCD touchscreen
- Semi-automatic needle threading
- Automatic thread cutting
- Start/stop button
- Function buttons: CL pattern clearing, ME pattern programming, MI mirroring, RE repeating patterns
- Smooth adjustment of sewing speed - up to 800 s.p.m.
- Reverse sewing and bartacking
- Extra-high presser foot lift up to 6 mm
- Drop feed dog
- Snap-on presser feet – MATIC system
- Free arm
- LED lighting

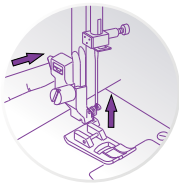

SYSTEM MATIC
quick-change feet



7-inch LCD
touchscreen



Free arm - easy
sewing in the round

00	01	02	03	04	05	06	07	08	09	10	11	12	13	14	15	16	17	18	19	20	21	22	23	24	25	26	27	28	29	30	31	32	33	34	35	36	37	38	39	40		
41	42	43	44	45	46	47	48	49	50	51	52	53	54	55	56	57	58	59	60	61	62	63	64	65	66	67	68	69	70	71	72	73	74	75	76	77	78					
79	80	81	82	83	84	85	86	87	88	89	90	91	92	93	94	95	96	97	98	99	100	101	102	103	104	105	106	107	108	109	110	111	112									
113	114	115	116	117	118	119	120	121	122	123	124	125	126	127	128	129	130	131	132	133	134	135	136	137	138	139	140	141	142	143	144	145	146									
147	148	149	150	151	152	153	154	155	156	157	158	159	160	161	162	163	164	165	166	167	168	169	170	171	172	173	174	175	176	177	178	179										



180 STITCHES

TEXI TANGO DUO

Computerized sewing and embroidery machine

NEW

5 YEARS OF WARRANTY

AUTOMATIC THREAD CUTTING

IMPORT EMBROIDERY DESIGNS VIA USB



PRICE & INFO



EQUIPMENT

Standard presser foot, buttonhole foot, overcasting foot, zipper foot, satin stitch foot, edge joining foot, embroidery foot, bobbins, needle set, seam ripper / cleaning brush, screwdriver, L-shaped screwdriver, spool caps (small and large), embroidery hoops (170x280 mm, 100x100 mm), power cord, instruction manual

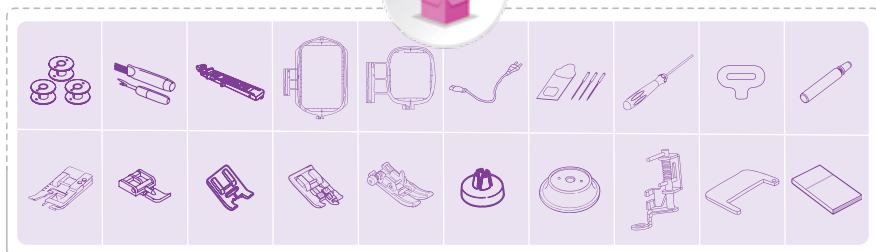

KEY FEATURES

- 140 built-in embroidery designs
- 6 fonts
- 29 utility stitches and 60 decorative stitches
- 11 buttonhole styles
- Automatic upper and lower thread trimming
- Built-in needle threader
- Colour 7-inch LCD touchscreen
- Start/Stop button
- Reverse sewing
- Metal frame
- Drop feed
- Bobbin winder with independent drive
- Sewing speed – 100 to 850 stitches per minute
- Adjustable stitch length (up to 5 mm) and stitch width (up to 7 mm)
- Editing designs and lettering on the screen
- USB embroidery import
- Snap-on presser feet - MATIC system
- Led Lamp

The Perfect Duo

SEWING AND EMBROIDERY MACHINE



001 002 003 004 005 006 007 008 009 010 011 012 013 014 015 016 017 018 019 020 021 022 023 024 025 026 027 028 029 030 031 032 033 034 035 036 037 038 039 040 041 042



043 044 045 046 047 048 049 050 051 052 053 054 055 056 057 058 059 060 061 062 063 064 065 066 067 068 069 070 071 072 073 074 075 076 077 078 079 080 081 082 083 084

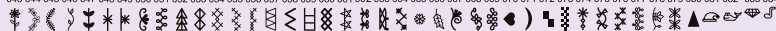

085 086 087 088 089 090 091 092 093 094 095 096 097 098 099 100 101 102 103 104 105 106 107 108 109 110 111 112 113 114 115 116 117 118 119 120 121 122 123 124 125



126 127 128 129 130 131 132 133 134 135 136 137 138 139 140 141 142 143 144 145 146 147 148 149 150 151 152 153 154 155 156 157 158 159 160 161 162 163 164 165 166 167



168 169 170 171 172 173 174 175 176 177 178 179 180 181 182 183 184 185 186 187 188 189 190 191 192 193 194 195 196 197 198 199 200 201 202 203 204 205 206 207 208 209

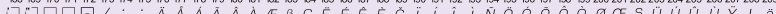

210 211 212 213 214 215 216 217 218 219 220 221 222 223 224 225 226 227 228 229 230 231 232 233 234 235 236 237 238 239 240 241

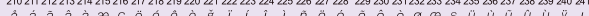

241 STITCHES

TEXI JOYLOCK

2, 3, 4-thread overlock machine for all types of materials



PRICE & INFO

5 YEARS WARRANTY



YOU'LL LOVE IT

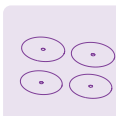

MAIN FUNCTIONS:

- 7 basic types of overlock stitches including rolled hem
- Differential feed ratio 0.7 – 2.0 mm
- Maximum sewing speed 1200 s.p.m.
- Stitch length 1 – 5 mm
- Stitch width up to 6 mm
- Presser foot lift up to 6 mm
- Adjustable presser foot pressure
- Mechanical integrated thread cutter
- Protection against machine start when looper threading ①
- Waste container ②

- Adjustable cutting width
- Deactivatable upper knife
- Color-coded threading system

EQUIPPED WITH:

lamp, 4 x spool pin cap, 4 x thread net, 4 x spool holder, tweezers, screwdriver x2, spanner, cleaning brush, machine oil, needle set, stitch finger, 2- thread converter, moving cutter, foot controller, soft cover, accessory bag



REMEMBER ABOUT:

TEXI 4079

A cleaning kit for each sewing machine



PRICE & INFO

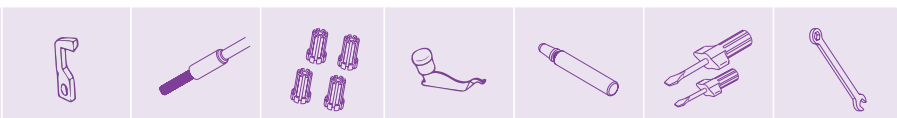

7 STITCHES

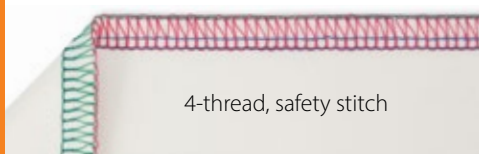

4-thread, safety stitch



3-thread, wide

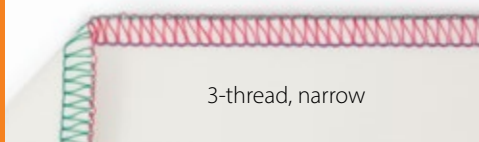

3-thread, narrow

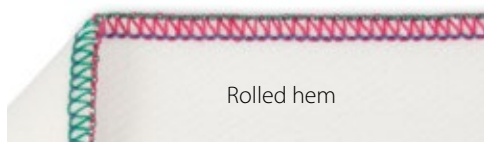

Rolled hem



Decorative overedge



3-thread overedge

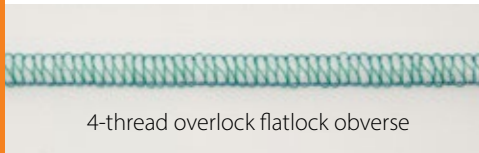

4-thread overlock flatlock obverse



2-thread overlock flatlock reverse

5 feet set for Texi overlocks

TEXI 1050



PRICE & INFO



EASY TO THREAD

- Lower looper
- Upper looper
- Right needle
- Left needle

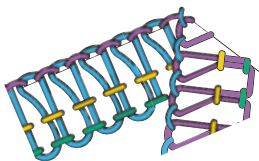

WIDE OPENING
FULL ACCESS
TO THE LOWER
LOOPERS

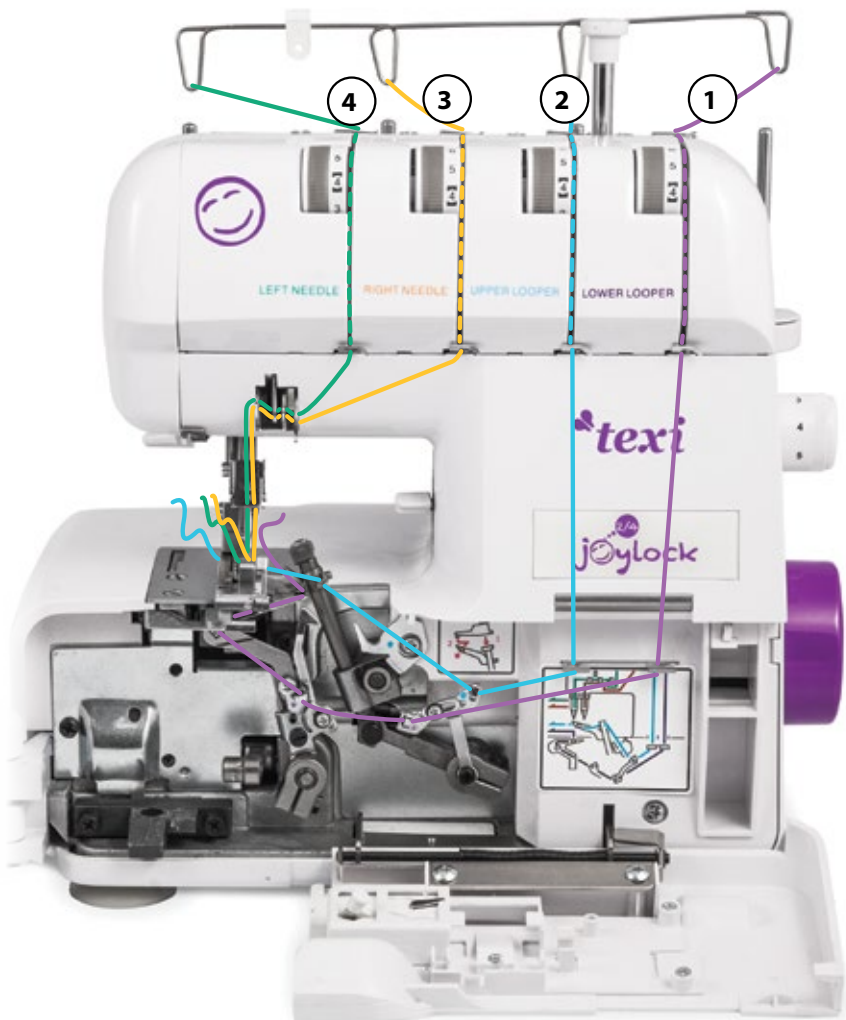

TEXI PIERROT PRO

2, 3, 4 thread overlock machine for all types of fabrics,
with adjustable differential feed, 16 overlock stitches

5 YEARS
WARRANTY

SEWING SPEED
UP TO 1200 S.P.M.

KNEE LIFTER



PRICE & INFO

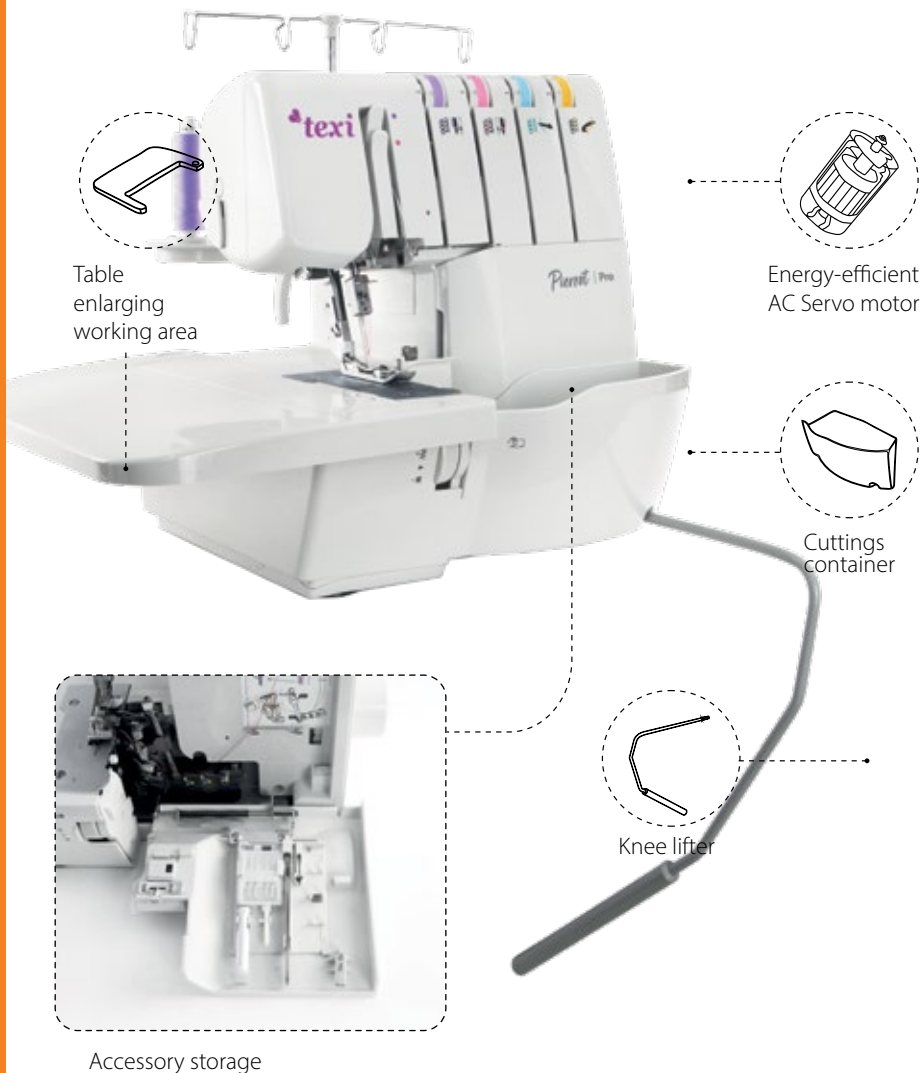

KEY FEATURES

- 16 overlock stitches, including:
4-thread overlock, 3-thread overlock,
3-thread flatlock, 3-thread wrapped edge
overlock, 2-thread overlock,
2-thread rolled hem
- Adjustable differential feed (0.7 - 2.0 mm)
- Maximum sewing speed
up to 1200 s.p.m.
- Adjustable length (1 mm - 5 mm)
and stitch width (up to 6 mm)
- Foot lift up to 6 mm
- Adjustable foot pressure
- Thread cutter
- Cuttings container
- Cutting width adjustment
- Switchable upper knife
- Coloured threading pattern
- Feet lift by knee lifter
- Easy feet exchange

6 BASIC STITCHES AND 10 SPECIALISED ONES

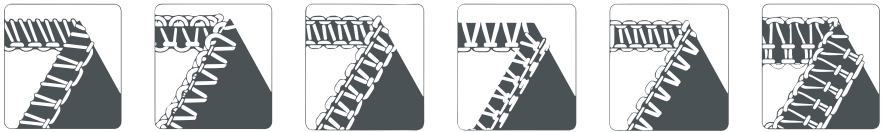

EQUIPMENT

Multi-purpose foot, needle set, screwdriver set and hexagonal key, cleaning brush cleaning brush, upper looper converter, vaseline oil (100 ml), cuttings container, enlargement table, tweezers, guide, spare knife, thread nets (3), thread cups (4 pcs) dust cover, accessory storage, foot control (pedal)

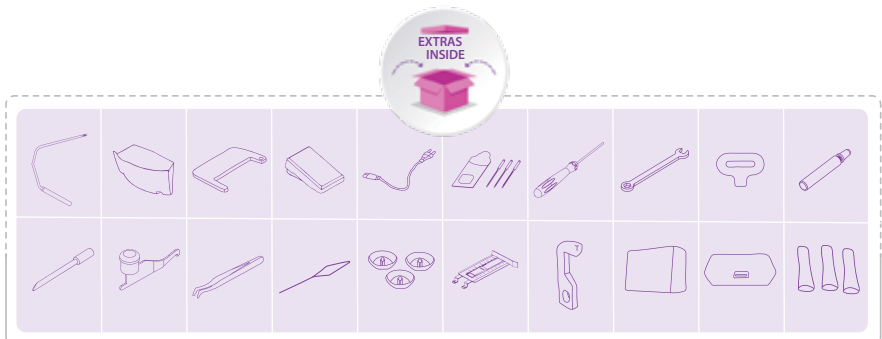

texi Cabinet for 2 machines



TEXI SESAME DUO

Folding cabinet for 2 sewing machines

A tailor's workshop in one closet?
Markers, scissors, rulers, buttonhole cutters, pins, needles, thread, tweezers, bobbins, feet, wires and other sewing accessories in one place. And most importantly - machine and overlock too. You push on the board and the sewing machine appears from under the work table as if by magic, and with one movement of your hand you slide out the shelf with the overlocker. When you're done, close it three times and you've got everything organized in a locked cabinet.



See the cabinet in action

TEXI DRESS FORM

dress form, page 50



texi Bags for machines

Texi bags are universal and fit most sewing machines.
Each has a pouch for sewing accessories.
Just enjoy!

TEXI ENJOY SEWING MACHINE BAG

Bag for household sewing machine



PRICE & INFO



TEXI ENJOY MAXI SEWING MACHINE BAG

Bag for household sewing machine, large



PRICE & INFO



TEXI ENJOY OVERLOCK BAG

Bag for household overlock machine



PRICE & INFO



TEXI ENJOY MAXI OVERLOCK BAG

Bag for household overlock machine, large



PRICE & INFO



texi. Accessories for household sewing machines

TEXI 0008

Invisible zipper foot, high fastening type



PRICE & INFO



TEXI 0009

Embroidery foot



PRICE & INFO



TEXI 0010

Sewing and shirring foot



PRICE & INFO

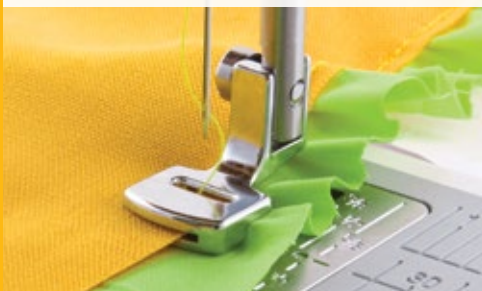

TEXI 0011

Shirring foot



PRICE & INFO



TEXI 0012

Application foot



PRICE & INFO



TEXI 0013

Roller foot for difficult fabrics



PRICE & INFO



TEXI 0014

Foot for piecing together two materials close to their edge



PRICE & INFO



TEXI 0019

Double-sided, wide, zipper and cording foot



PRICE & INFO



Double-sided, narrow zipper foot for household machine

TEXI 0017

Low fastening type



PRICE & INFO



TEXI 0018

High fastening type



PRICE & INFO

TEXI 0022

Ruffler



PRICE & INFO



TEXI 0023

Flower stitch foot



PRICE & INFO



TEXI 0024
Even feed foot



PRICE & INFO



TEXI 0025
Overlock foot
with trimmer



PRICE & INFO



TEXI 0026
Cord sewing foot



PRICE & INFO

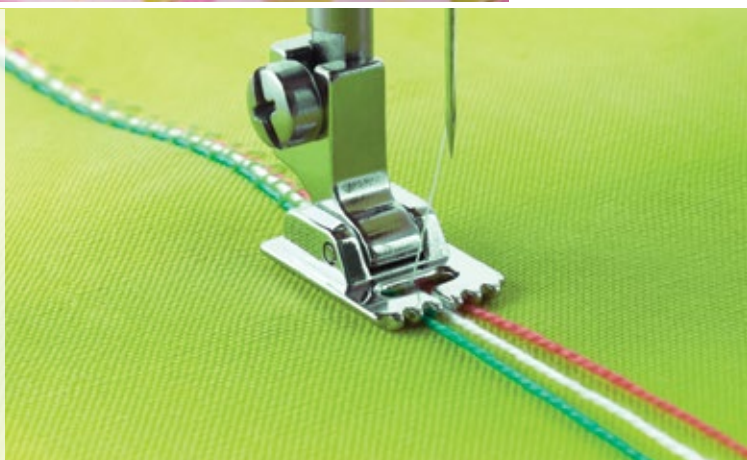

SYSTEM MATIC

Check what holder you have in your machine. Measure the height, from the bottom of the foot, to the screw that secures the handle to the needle bar. If the distance is about 1.5 cm, it means that we have a low type of foot mounting in our machine. The vast majority of household machines have this type of handle. If the distance from the bottom of the mounted foot to the screw is approximately 2.5 cm, it is a high foot mount.



MATIC

SYSTEM MATIC
presser foot holder

TEXI 1001

Low fastening type
(holder height 1.5 cm)

TEXI 1002

High fastening type
(holder height 2.5 cm)



LOW



HIGH



TEXI 1003

MATIC universal foot



PRICE & INFO

TEXI 1004

MATIC universal foot,
plastic



PRICE & INFO

MATIC

TEXI 1005

MATIC sliding
buttonhole foot



PRICE & INFO

TEXI 1006

MATIC
application foot



PRICE & INFO

TEXI 1008

MATIC button foot



PRICE & INFO

TEXI 1009

MATIC double-sided zipper foot



PRICE & INFO

TEXI 1010MATIC double hemming foot
1/16" (1.6 mm)

PRICE & INFO

TEXI 1011

MATIC adjustable guide foot



PRICE & INFO

TEXI 1012

MATIC cording foot



PRICE & INFO

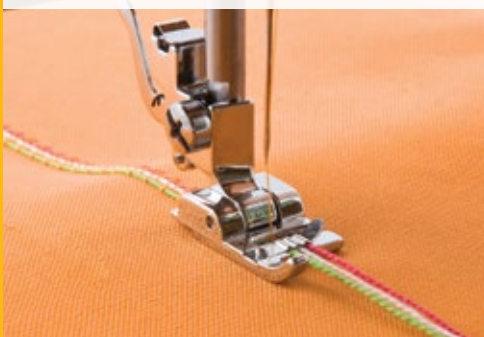

TEXI 1013

MATIC overcast
guide foot



PRICE & INFO

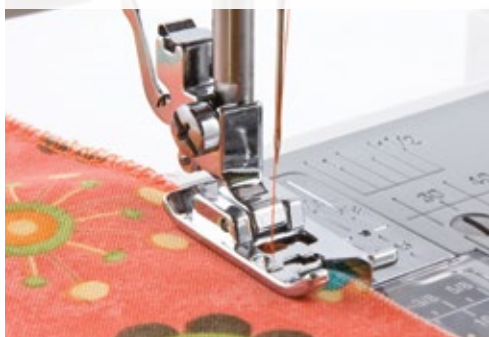

TEXI 1014

MATIC quilter's guide



PRICE & INFO

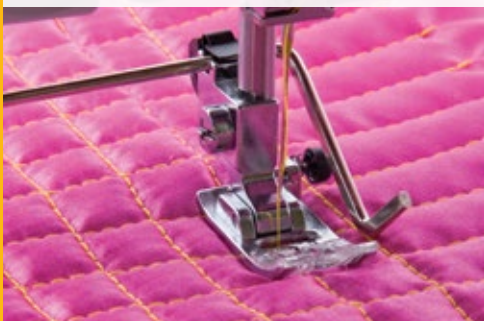

TEXI 1015

MATIC invisible
zipper foot



PRICE & INFO

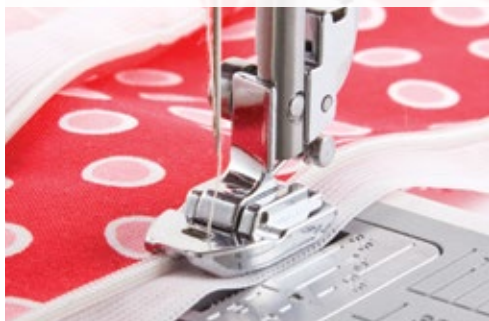

TEXI 1016

MATIC roller foot for
difficult fabrics



PRICE & INFO



TEXI 1017

MATIC bin justable
5-20 mm



PRICE & INFO





TEXI 2001

Binders and
hemmers fastening
handle



PRICE & INFO

BINDING

PIPING



TEXI 2002

A = 7/32" (5,5 mm)

TEXI 2003

A = 1/10" (2,5 mm)

TEXI 2004

A = 1/4" (6,4 mm)

TEXI 2005

A = 3/8" (9,5 mm)

TEXI 2006

A = 5/8" (16 mm)

TEXI 2007

A = 7/8" (22 mm)

Texi Universal Accessories



TEXI 3003 SET 3

Bobbin
(metal, flat)
3 pcs



PRICE & INFO



TEXI 3004 SET 3

Bobbin
(plastic, flat)
3 pcs



PRICE & INFO



TEXI 3010 SET 3

Bobbin
(plastic, convex)
3 pcs



PRICE & INFO



TEXI 4005

Tweezers



PRICE & INFO



TEXI 4033

Storage box for 25
bobbins



PRICE & INFO



TEXI 4079

Set for cleaning the
machine



PRICE & INFO

TEXI 4047

Loop turner



PRICE & INFO

TEXI 4046

Tailor's awl for pietcing holes for rivets, snaps, eyelets

11,5 cm



PRICE & INFO

TEXI 4083

Button hole cutting knife



PRICE & INFO

TEXI 4049

Knit picker



PRICE & INFO

TEXI 4048

Finger presser tool



PRICE & INFO



TEXI 4013

Pencil
for fabrics:
white + color



PRICE & INFO



TEXI 4014

Disappearing pen
violet - pink



PRICE & INFO



TEXI 4015

Disappearing
pen



PRICE & INFO



TEXI 4016

Eraser for
disappearing
pen



PRICE & INFO



TEXI 4040

Tailor chalk pen with applicator



PRICE & INFO



TEXI 4041

Refill for pen
with applicator



PRICE & INFO



TEXI 4075

Flower head steel pins,
nickel plated
0.6 x 48 mm,
box of 80 pcs.



PRICE & INFO



TEXI 4076

Steel pins, nickle plated
0.6 x 48 mm,
box of 75 pcs.



PRICE & INFO



TEXI LOVE

Magnetic bracelet



PRICE & INFO



TEXI 4082

Needle threader



PRICE & INFO



TEXI 4029

Magnetic pin and
needle holder



PRICE & INFO

TEXI 4034

Seam ripper



PRICE & INFO





TEXI 4080

A set of smart accessories for every seamstress



PRICE & INFO

TEXI 4011

Brush for naps lifting



PRICE & INFO

TEXI BOX 15

Set of thread 15 colors, household machine needles and leaflet



PRICE & INFO

TEXI 4006

Cleaning roll with handle
(1 roll = 10 mts)



PRICE & INFO

TEXI 4006R

Spare roll, tape lenght
10 mts



TEXI 4035

Tape makers set:
TEXI 4036 + TEXI 4037 + TEXI 4038



PRICE & INFO



TEXI 4036

A = 24 mm
B = 12 mm

TEXI 4037

A = 36 mm
B = 18 mm

TEXI 4038

A = 50 mm
B = 25 mm



TEXI 4020

Iron foot cleaning stick

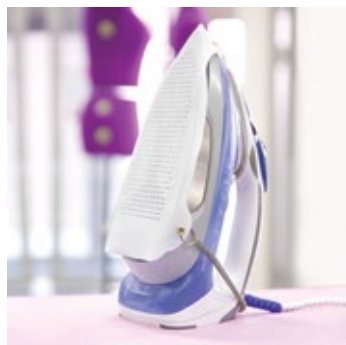

TEXI 4001

PTFE anti-shine



TEXI 4002

Thermal adhesive powder



PRICE & INFO



PRICE & INFO



PRICE & INFO

1 *texi. Craft* Mats and rulers

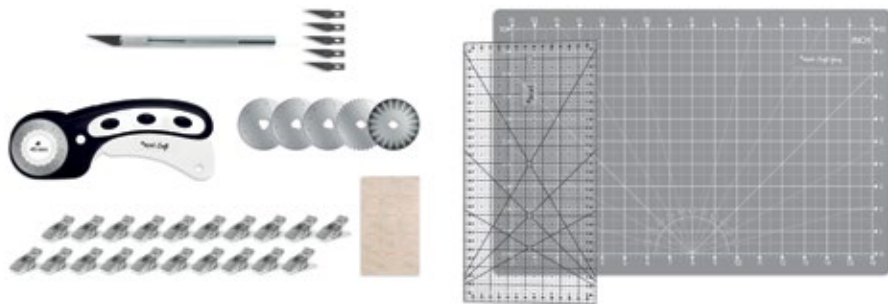

7 **TEXI CRAFT GRAY 45 X 30**

Set includes: rotary cutter 45 mm, self-healing mat, spare blades, ruler, craft knife with additional blades, fabric clips and anti-slip stickers



PRICE & INFO

9 Sets in different colors

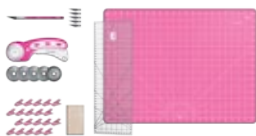

10 **TEXI CRAFT**
11 **PINK 60 X 45 SET**

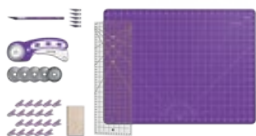

12 **TEXI CRAFT**
13 **PURPLE 60 X 45 SET**

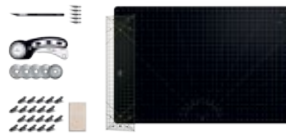

14 **TEXI CRAFT**
15 **BLACK 90 X 60 SET**

16 Rulers for patchwork and quilting

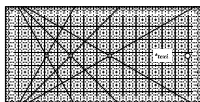

17 15 x 30 cm, black

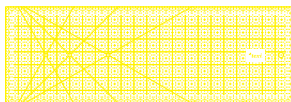

18 15 x 45 cm, yellow

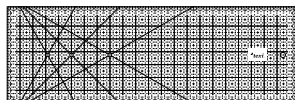

19 15 x 45 cm, black

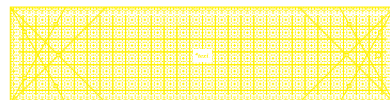

15 x 60 cm, yellow

TEXI 4097

Sewing clips 20 pcs
38 x 11 x 15 mm,
color mix



PRICE & INFO

TEXI 4106

Rotary cutter,
Ø 45 mm



PRICE & INFO

TEXI 4107

Craft knife



PRICE & INFO

Which blade do you need?? Straight, curved, wavy?

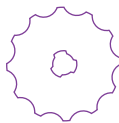
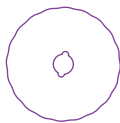
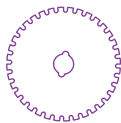

PRICE & INFO

Cutting
mat



PRICE & INFO

TEXI PINK

45 x 30 cm
60 x 45 cm
90 x 60 cm

TEXI BLACK

45 x 30 cm
60 x 45 cm
90 x 60 cm

TEXI BLUE

45 x 30 cm
60 x 45 cm
90 x 60 cm

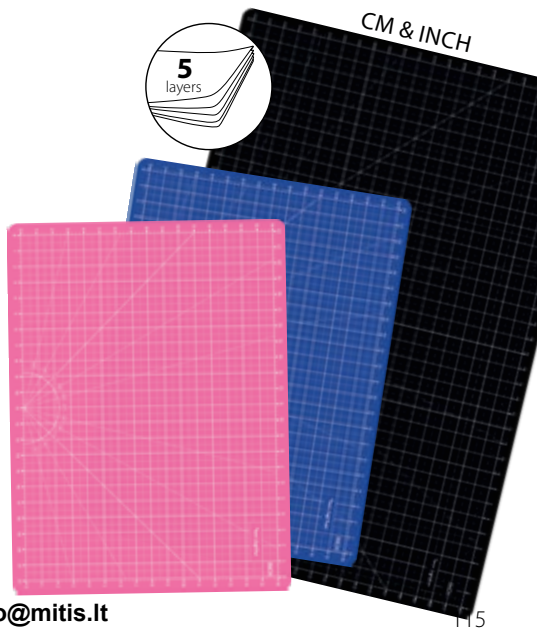
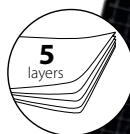

info@mitis.lt

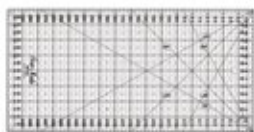

TEXI 4065

Quilting ruler, metric scale,
160 x 320 mm, black



PRICE & INFO

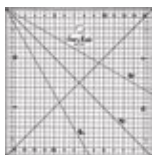

TEXI 4066

Quilting ruler, metric scale,
160 x 160 mm, black



PRICE & INFO



TEXI 4067

Quilting ruler, metric scale,
160 x 320 mm, yellow



PRICE & INFO



TEXI 4068

Ruler handle - 2 caps



PRICE & INFO



TEXI 4069

Ruler handle - 1 cap



PRICE & INFO



TEXI 4007

Tailor's tape measure,
length 150 cm,
width 19 mm



PRICE & INFO



TEXI 4008

Rollfix textile tape measure
- reversible 150 cm



PRICE & INFO

15 x 60 cm, yellow



PRICE & INFO



texi Rotary Cutters



TEXI 4050
∅ 18 mm



TEXI 4051
∅ 28 mm



TEXI 4053
∅ 45 mm



TEXI 4054
∅ 60 mm

ROTARY CUTTER BLADES



straight



skip



wave

∅ 18 mm

∅ 28 mm

∅ 45 mm

∅ 60 mm

TEXI 4055

TEXI 4056
TEXI 4058
TEXI 4059

TEXI 4057

TEXI 4060



MODEL	SURFACE	HEIGHT ADJUSTMENT	BOARD POWER	IRON POWER	VACUUM	BLOWING	STEAM GENERATOR POWER	ONE FINGER OPERATION	SLEEVE BUCK
TEXI BIB	40 x 120 cm	81 - 100 cm	-	-	-	-	-	-	-
TEXI CHAMPION SB	45 x 120 cm	85 - 102 cm	400 W	-	35 W	35 W	-	-	-
TEXI SMART S+B	45 x 120 cm	60 - 105 cm	200 W	800 W	40 W	40 W	1 300 W	✓	✓

TEXI SLEEVE BUCK

Universal ironing sleeve buck,
52 cm long



PRICE & INFO



TEXI BIB

Iron table,
chromium-plated,
40 x 120 cm



PRICE & INFO



PRICE & INFO

TEXI CHAMPION SB

Ironing table board type
45 x 120 cm, with suction,
blowing and heated surface

TEXI SMART S+B

Compact ironing table with automatic, integrated steam generator and iron



PRICE & INFO



TEXI 1081



TEXI SMART S+B BRUSH



texi Heat presses



TEXI FHP4060

Working area
40 x 60 cm



TEXI FHP3838

Working area
38 x 38 cm



TEXI MHP

Compatible
with 17 oz cups



TEXI CHP

Working area
10 x 20 cm

texi Steam presses

HOME ATELIER LAUNDRY HOTEL



DIGITAL CONTROL



Electronically controlled ironing presses

TEXI APOLLO 68

Ironing surface 66 x 26 cm, 1600 W

TEXI APOLLO 101

Ironing surface 99 x 29 cm, 2200 W



PRICE & INFO

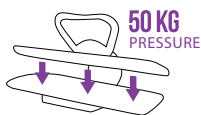

Force of 18 irons

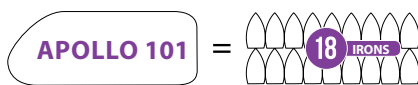

TEXI AP01

Stand for the Apollo ironing press, height 93 cm



PRICE & INFO



PRICE & INFO

TEXI AP02

Telescopic stand for apollo ironing press height 63 - 73 cm



info@mitis.lt



17 **TEXI BLACK TURBO 2**

18 The TEXI Black Turbo 2 high-pressure steamer delivers professional power,
19 outstanding efficiency, and rock-solid reliability – giving you flawless results
with maximum comfort and zero effort.



PRICE & INFO



ADJUSTABLE ANGLE

The ironing board angle can be adjusted, horizontally, vertically or at an setangle



Shoulder-shaped IRONING BOARD



STEAM HEAD

Triangular shape to access any corner of clothes



TELESCOPIC POLE

to meet your comfortable height

WATER TANK with a capacity of 2.9 L

- Extended working time – a 2.9 L water tank delivers up to 72 minutes of continuous steaming, almost 3 times longer than many competitors.
- 2450 W power and 5.5 bar steam pressure – ensure a strong, consistent steam flow (40–100 g/min) that smooths even thick fabrics and stubborn wrinkles.
- Professional build quality – titanium-aluminium alloy boiler and PA6+PA66 aluminium steam head for even heat distribution and long durability.
- Comfort & ergonomics – adjustable aluminium telescopic pole, large shoulder-shaped ironing board and ergonomic handle for effortless use.
- Mobility & stability – heavy base with casters for easy movement and safe operation.
- Safety first – protection system, water shortage alarm and automatic shut-off for worry-free steaming.



PRICE & INFO

TEXI 75S TAG GUN

Tagging gun - standard

TEXI 75F TAG GUN

Tagging gun for fastening labels with fine tagging pins



common

gentle

Needles for tag guns



PRICE & INFO



TEXI 75S NEEDLE

Standard 1,85 mm



TEXI 75F NEEDLE

Fine 1,32 mm



TEXI 75S NEEDLE PREMIUM

Standard 1,85 mm



TEXI 75F NEEDLE PREMIUM

Fine 1,32 mm

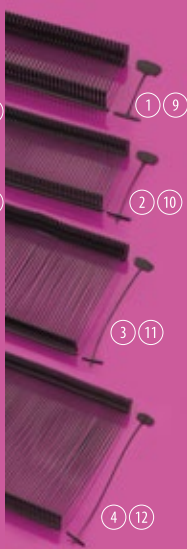
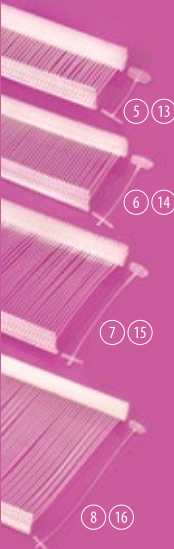

TEXI 75 PPS STANDARD

1	TEXI 75 PPS BLACK 015	15 mm
2	TEXI 75 PPS BLACK 025	25 mm
3	TEXI 75 PPS BLACK 045	45 mm
4	TEXI 75 PPS BLACK 065	65 mm
5	TEXI 75 PPS NEUTRAL 015	15 mm
6	TEXI 75 PPS NEUTRAL 025	25 mm
7	TEXI 75 PPS NEUTRAL 045	45 mm
8	TEXI 75 PPS NEUTRAL 065	65 mm

TEXI 75 PPF FINE

9	TEXI 75 PPF BLACK 015	15 mm
10	TEXI 75 PPF BLACK 025	25 mm
11	TEXI 75 PPF BLACK 045	45 mm
12	TEXI 75 PPF BLACK 065	65 mm
13	TEXI 75 PPF NEUTRAL 015	15 mm
14	TEXI 75 PPF NEUTRAL 025	25 mm
15	TEXI 75 PPF NEUTRAL 045	45 mm
16	TEXI 75 PPF NEUTRAL 065	65 mm

Pins for manual labeling

TEXI 75 PP SECUR LOOP 230

TEXI 75 PP SECUR LOOP 130





I'M SO

so
texi®





Telephone sales **+370 614 67 014**



Texi Dealer

UAB MITIS
T. Žebrausko g. 7,
LT-14188 Vilnius,
Lithuania
tel.: +370 614 67 014
Email: info@mitis.lt
www.mitis.lt

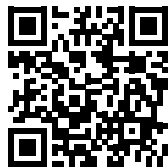

@texiatelier

